



NM1 Moulded Case Circuit Breaker

1. General

- 1.1 Certificates: KEMA, UKrSEPRO, EAC, RCC, EK;
- 1.2 Electric ratings: AC 690V,50/60HZ, 10~1250A;
- 1.3 Mounting mode: Vertical and horizontal;
- 1.4 Standard: IEC/EN60947-2.

2. Type designation

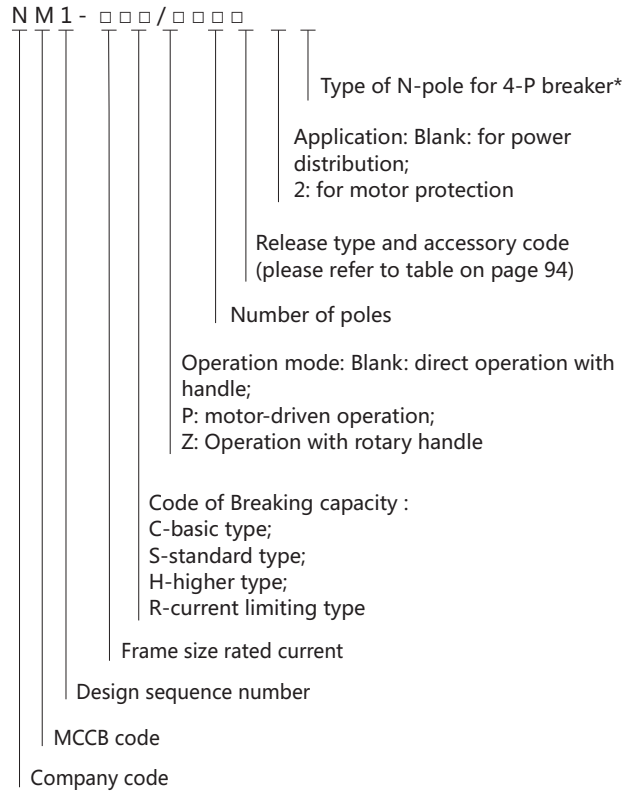

Note *: There is types of N-pole for 4P breaker
 B: Without current release components, N-Pole makes with the other three poles(N-pole first makes then breaks);

3. Classification

According to breaking capacity of breaker:

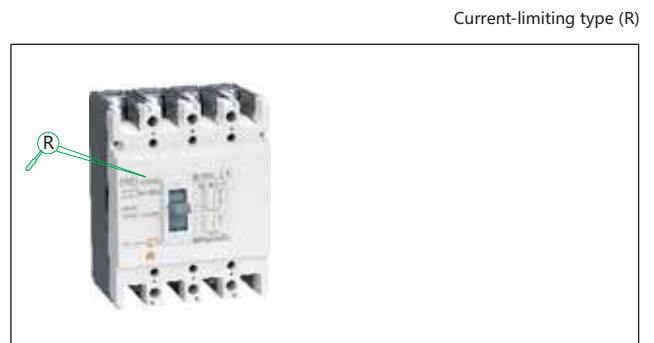
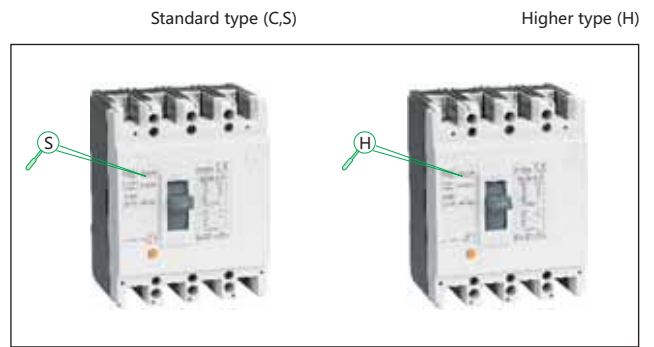

According to wiring mode:

Front connection



According to operation mode:

Direct operation with handle



Operation with rotary handle



Motor-driven operation



According to number of poles:

2P



3P



4P



4. Operating conditions

4.1 Temperature: $-5^{\circ}\text{C} \sim +40^{\circ}\text{C}$; the average value within 24h shall not exceed $+35^{\circ}\text{C}$. (please refer to coefficients on P79 for temperature compensation correction); for the circuit breaker with thermo-magnetic release, $+40^{\circ}\text{C}$ is set to be the standard temperature for ratings. For temperature not between $-5^{\circ}\text{C} \sim +40^{\circ}\text{C}$, please contact us for temperature compensation correction.

4.2 Altitude: not exceed 2000m (Please contact with us for reduction coefficient if altitude at the mounted site beyond 2000m).

4.3 Pollution grade: Grade 3

4.4 Air conditions

At mounting site, relative humidity not exceed 50% at the max temperature of $+40^{\circ}\text{C}$, higher relative humidity is allowable under lower temperature. For example, RH could be 90% at $+20^{\circ}\text{C}$, special measures should be taken to occurrence of dews.

Moulded Case Circuit Breakers
NM1

5. Technical data

Frame size current	63					125					250					400				630				800			1250					
Electric characteristics as per IEC 60947-2, EN 60947-2																																
Rated current (A) I _n 40°C	10, 16, 20, 25, 30, 32, 40, 50, 63					25, 30, 32, 40, 50, 63, 80, 100, 125					100, 125, 140, 150, 160, 175, 180, 200, 225, 250					250, 300, 315, 350, 400				400, 450, 500, 630				630, 700, 800			800, 1000, 1250					
Rated insulation voltage (V) U _i	500					800					800					800				800				800			800					
Rated impulse withstand voltage(kV) U _{imp}	6					8					8					8				8				8			8					
Rated operational voltage (V) U _e AC 50/60Hz	415					690					690					690				690				690			690					
Arcing distance (mm)	≤50					≤50					≤50					≤100				≤100				≤100			≤100					
Breaking capacity code	S	H				C	S	H			R	C	S	H		R	S	H		R	S	H		R	S	H		R	H	R		H



Number of poles	3	3	4	3	3	2	3	4	3	2	3	4	1	3	4	2	3	4	3	3	4	3	3	3	4	3	3	3	4	3	3	3	4	3	3	3	4	3	3	4	3	3
Rated ultimate short-circuit breaking capacity I _{cu} (kA, rms)	AC 220/230/240V	20	42	42	25	42	65	65	65	85	25	25	25	20	42	42	65	65	65	85	50	50	85	100	50	50	85	100	85	85	100	85	85	100	85	85	100	85	85	100	85	85
	AC 380/400/415V	15	35	35	20	25	50	50	50	65	20	20	20	10	25	25	50	50	50	65	35	35	50	70	35	35	50	70	60	60	70	60	60	70	60	60	70	60	60	70	60	60
	AC 660/690V	-	-	-	3	3	-	8	8	10	-	5	5	-	5	5	-	8	8	10	10	10	12	15	12	12	15	15	20	20	20	20	20	20	20	20	20	20	20	20	20	20
Rated service short-circuit breaking capacity I _{cs} (%I _{cu})	50%																																									
Test sequence: O-t-CO	50%																																									
Isolation function	■					■					■					■				■				■			■															
Utilization class	A					A					A					A				A				A			A															
Front connection	■																																									
Rear connection	■																																									
Plug in type	■																																									
Shunt release	■																																									
Under-voltage release	■																																									
Auxiliary contact	■																																									
Alarm contact	■																																									

Note:

The symbols O-t-Co, O-t-Co-t-Co are used for defining the sequence of operations.
O: breaking operation; t: the time interval between two successive short-circuit operations;
CO: a making operation followed, after the appropriate opening time, by a breaking operation.

6. Release

Inverse time breaking action property of the over current releasing of the breaker (for power distribution) at the status that all poles are electrified simultaneously

No.	Test current	I/In	Conventional time	Initial status
1	Conventional non-trip current	1.05	2h(In>63A), 1h(In≤63A)	Cold status
2	Conventional trip current	1.30	2h(In>63A), 1h(In≤63A)	Right after test no. 1

Inverse time-delay breaking operation property of the over current tripping of the breaker(for motor protection) at the status that all poles are electrified simultaneously(conforms to IEC60947-3)

Serial No.	Setting current	Conventional time	Start-up status	Remark
1	1.0In	>2h	Cold state	
2	1.2In	≤2h	Right after test number 1	
3	1.5In	≤2min	Hot state	10A≤In≤25A
		≤4min	Hot state	25A≤In≤63A
		≤8min	Hot state	63A≤In≤125A
4	7.2In	0.5s≤Tp≤5s	Cold state	125A≤In≤800A
		2s≤Tp≤10s	Cold state	10A≤In≤25A
		4s≤Tp≤10s	Cold state	25A≤In≤63A
		6s≤Tp≤20s	Cold state	63A≤In≤125A
				125A≤In≤800A

7. Product overview

NM1 Moulded Case Circuit Breaker

- 1 MCCB (fixed type)
- 2 Under-voltage release
- 3 Shunt release
- 4 Alarm contact
- 5 Auxiliary contact
- 6 Motor-driven operation mechanism
- 7 Extended manual operation handle
- 8 Mechanical interlock
- 9 Cage clamp terminal
- 10 Terminal cover
- 11 Front connection plate

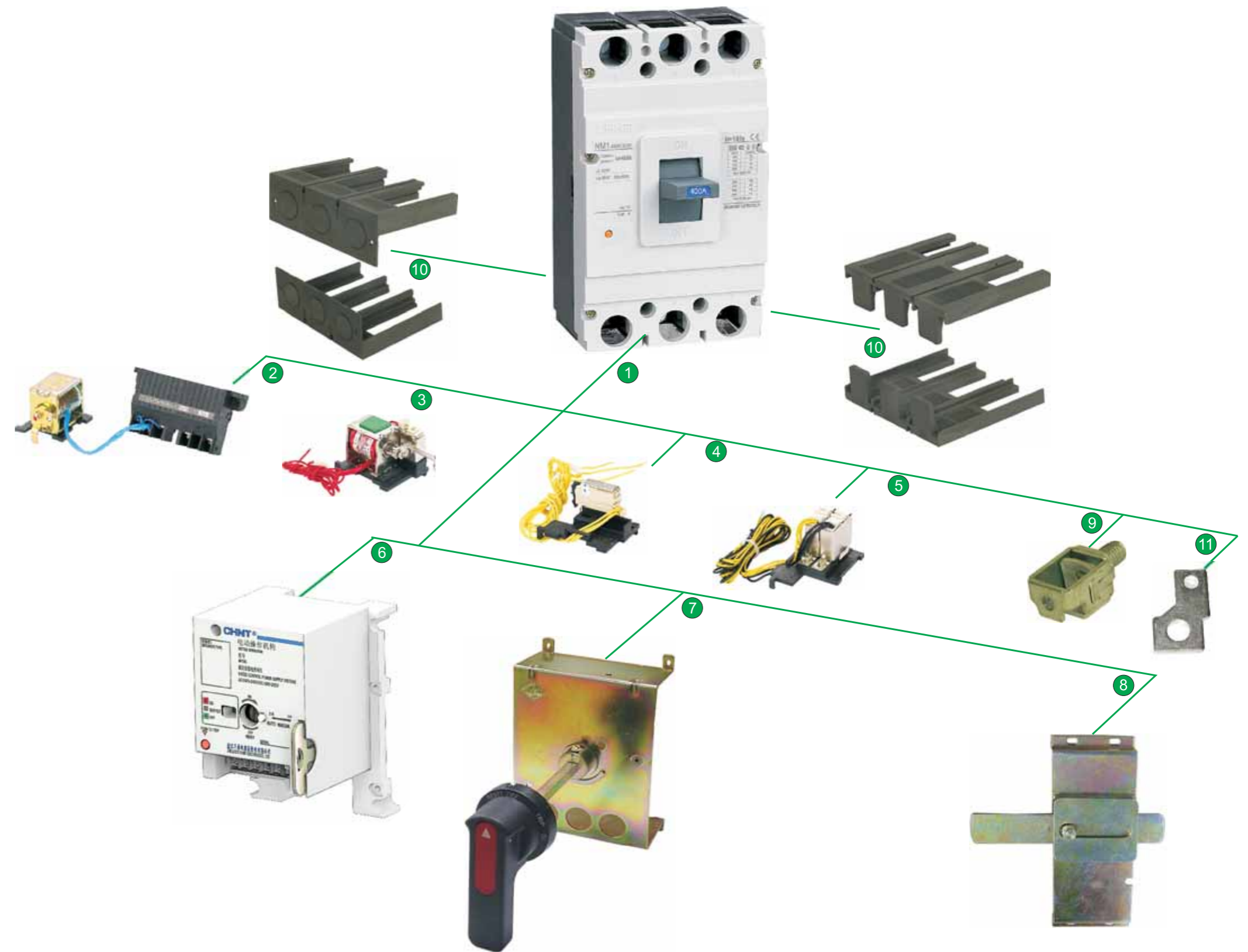

8. Curves (for power distribution, calibrated at 40°C)

8.1 The characteristic curve of anti-time limit and the correcting curve of temperature see fig.

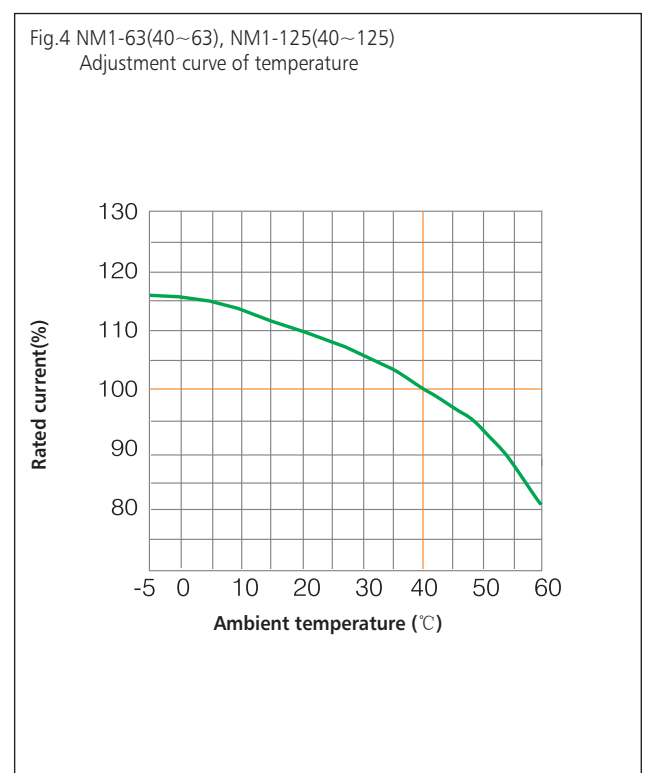
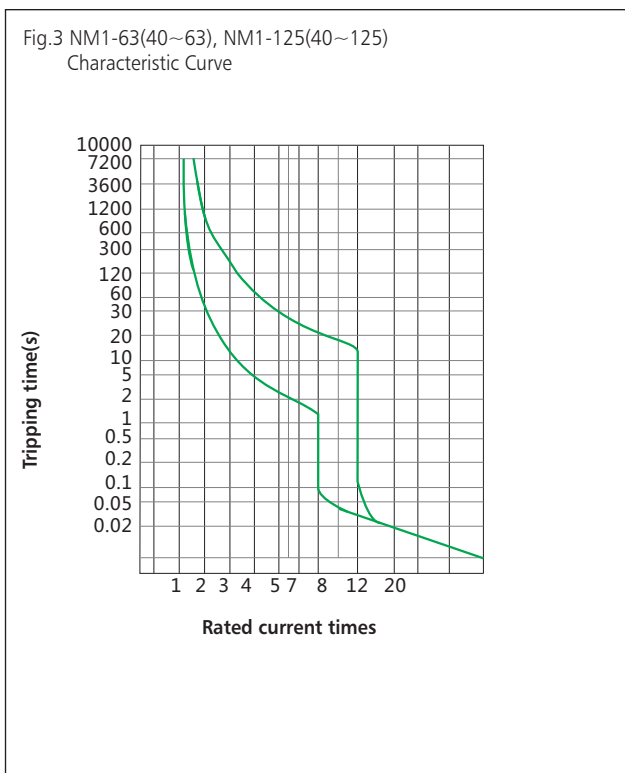
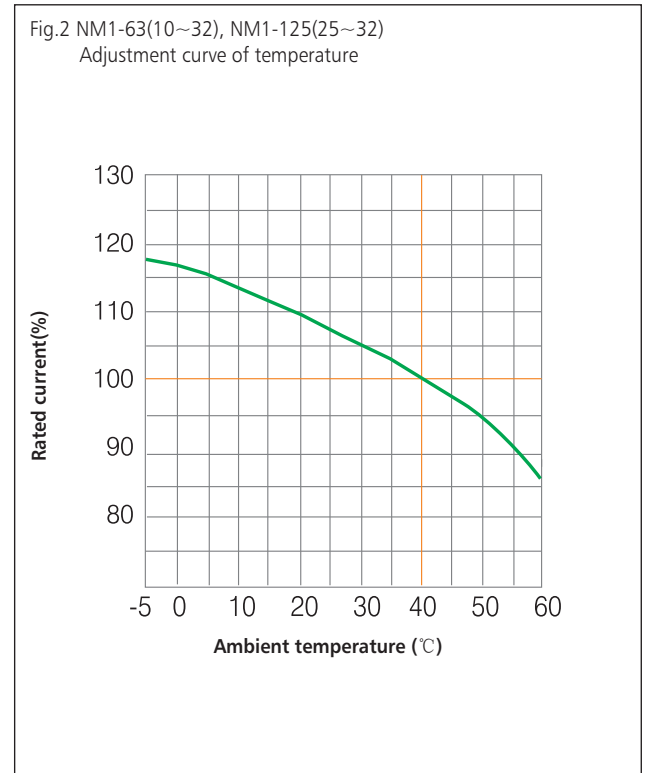
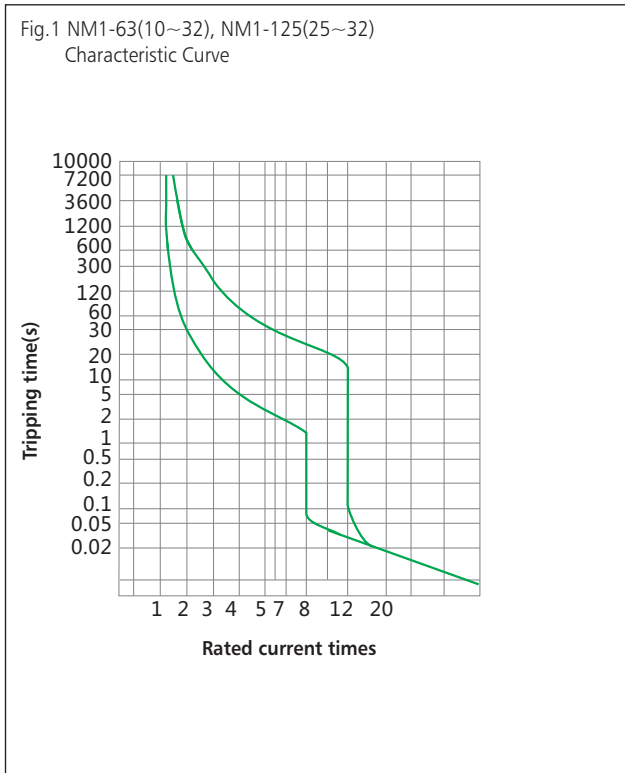

Fig.5 NM1-250 Characteristic Curve

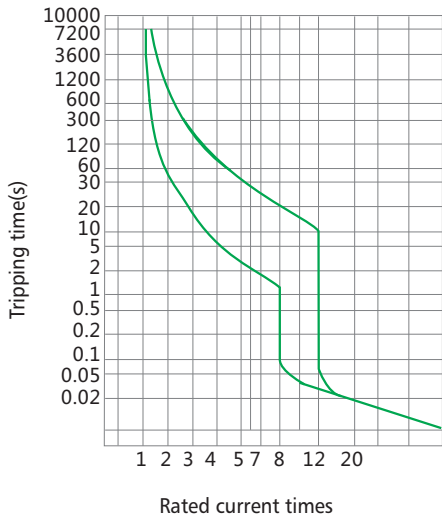

Fig.6 NM1-250 Adjustment curve of temperature

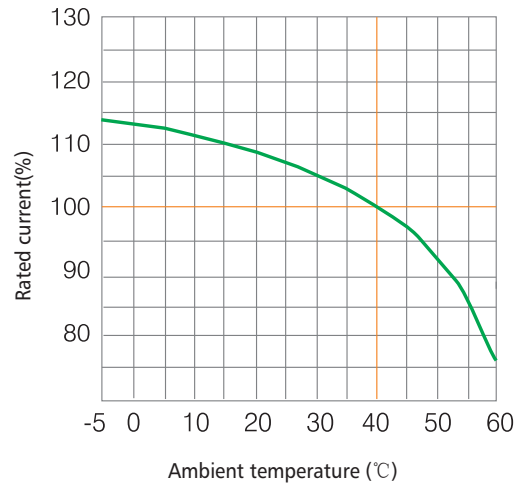

Fig.7 NM1-400 Characteristic Curve

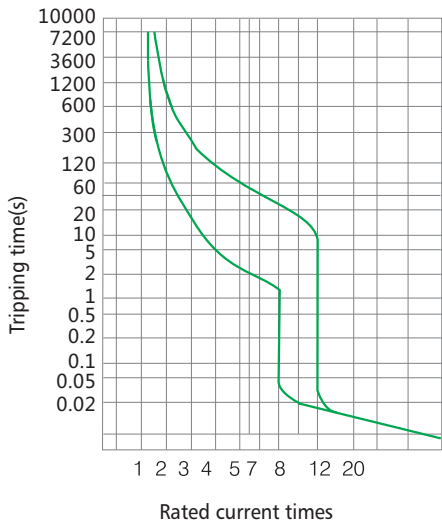

Fig.8 NM1-400 Adjustment curve of temperature

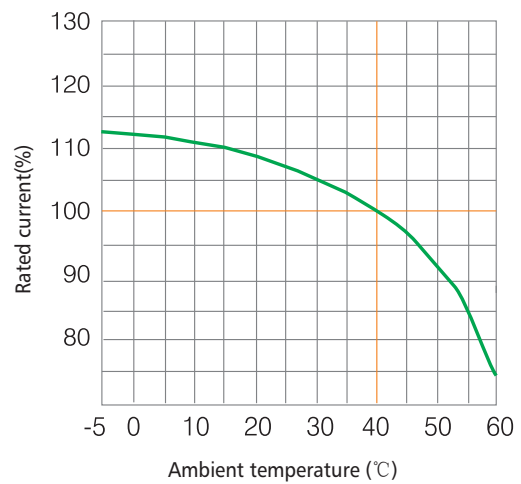



Fig.9 NM1-630, NM1-800 Characteristic Curve

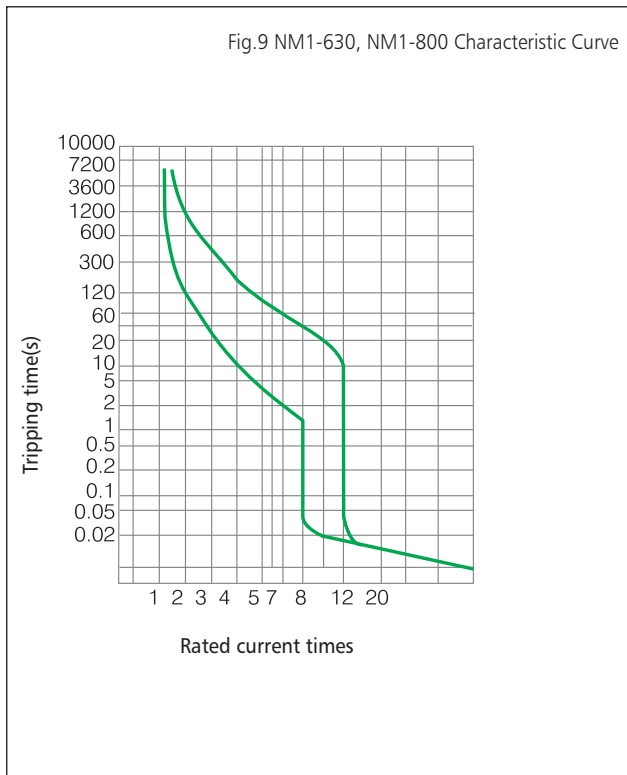

Fig.10 NM1-630, NM1-800 Adjustment curve of temperature

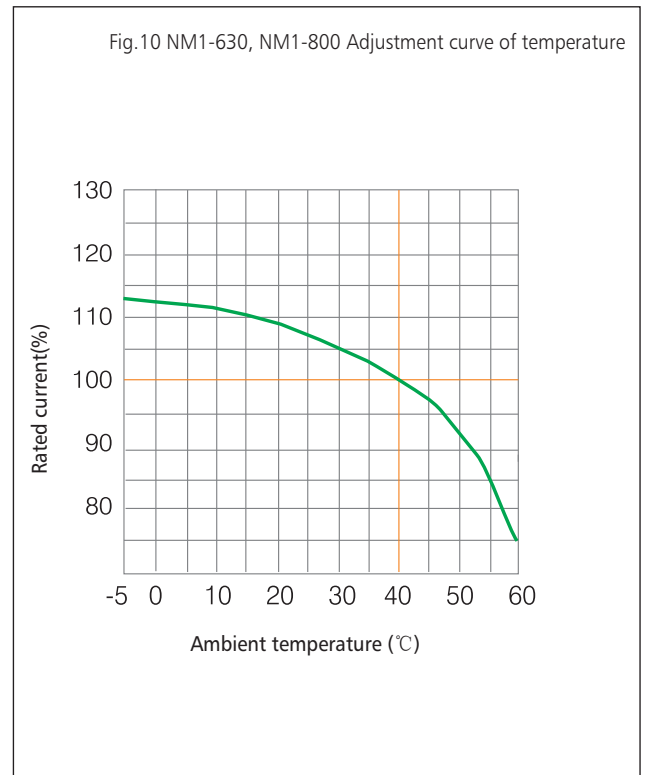

Fig.11 NM1-1250 Characteristic Curve

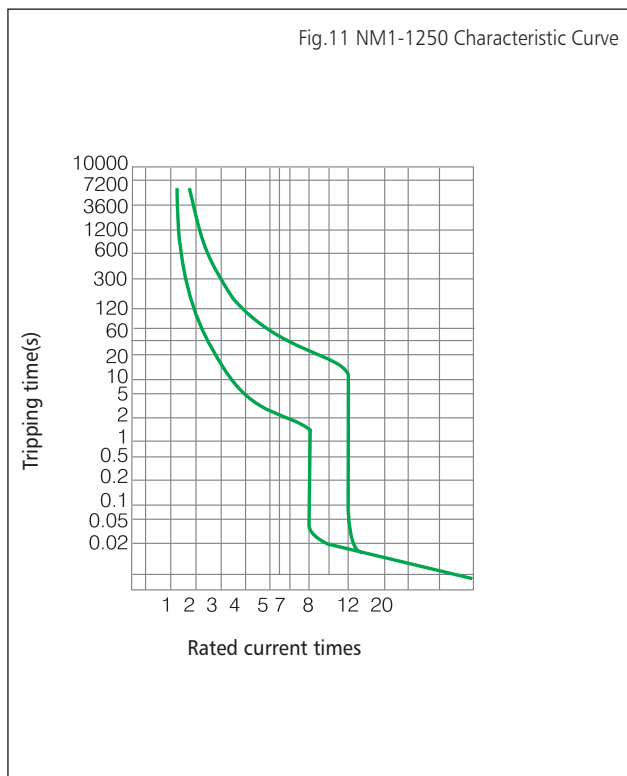
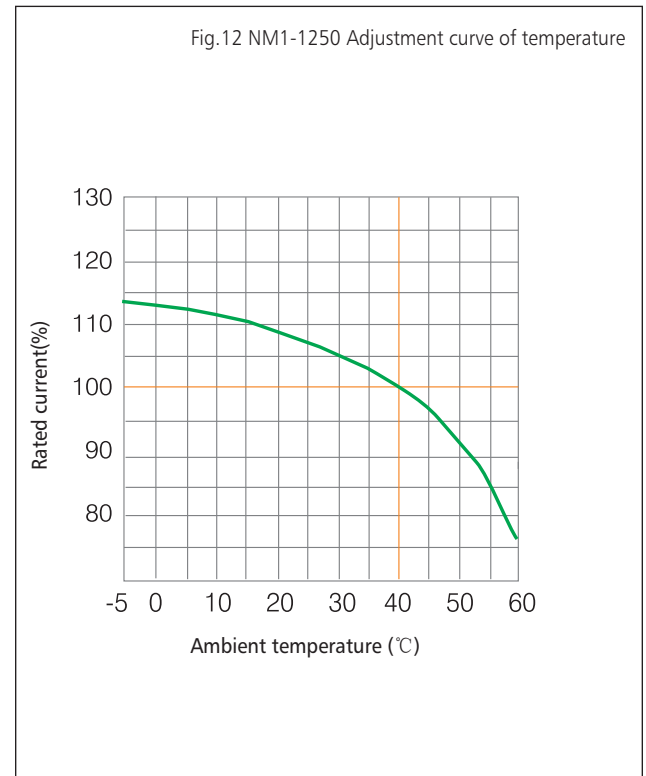

Fig.12 NM1-1250 Adjustment curve of temperature



8.2 Temperature compensation correction

NM1 series temperature compensation coefficient table (calibration at 40°C, for the calibration at other temperature standards please contact with us)

Type	Current range	Compensation coefficient													
		-5°C	0°C	5°C	10°C	15°C	20°C	25°C	30°C	35°C	40°C	45°C	50°C	55°C	60°C
NM1-63S, H	10~32A	1.18	1.17	1.16	1.14	1.12	1.09	1.07	1.05	1.03	1	0.97	0.95	0.92	0.87
NM1-63S, H	40~63A	1.16	1.16	1.15	1.14	1.12	1.10	1.08	1.06	1.03	1	0.97	0.94	0.87	0.82
NM1-125C, S, H, R	25~32A	1.18	1.17	1.16	1.14	1.12	1.09	1.07	1.05	1.03	1	0.97	0.95	0.92	0.87
NM1-125C, S, H, R	40~125A	1.16	1.16	1.15	1.14	1.12	1.10	1.08	1.06	1.03	1	0.97	0.94	0.87	0.82
NM1-250 S, H, R	100~250A	1.14	1.13	1.13	1.12	1.10	1.08	1.07	1.05	1.03	1	0.97	0.93	0.86	0.76
NM1-400S, H, R	225~400A	1.13	1.12	1.12	1.11	1.10	1.08	1.06	1.05	1.03	1	0.97	0.93	0.85	0.75
NM1-630S, H, R	400~630A	1.13	1.12	1.12	1.11	1.10	1.08	1.07	1.05	1.03	1	0.97	0.93	0.85	0.75
NM1-800S,H, R	630~800A	1.13	1.12	1.12	1.11	1.10	1.08	1.07	1.05	1.03	1	0.97	0.93	0.85	0.75
NM1-1250H	700~1250A	1.14	1.13	1.12	1.11	1.10	1.09	1.07	1.05	1.03	1	0.97	0.92	0.85	0.76

9. Wiring

Front connection(Fixed connection)

Extended connection terminals (for products 10~1250A, extended terminals are available)

Connection screws



Frame level	Current (A)	Breaking capacity code	Front connection screw		
			Hexagonal head screw (A)	Hexagonal socket screw (B)	Cross screw (C)
63	10	S		■	
		H		■	
	16	S		■	
		H		■	
	20	S		■	
		H		■	
	25	S		■	
		H		■	
	30	S		■	
		H		■	
	32	S		■	
		H		■	
	40	S		■	
		H		■	
	50	S		■	
		H		■	
	60	S		■	
		H		■	
63	S		■		
	H		■		
125	25	C		■	■
		S		■	■
		H		■	■
	30	R		■	■
		C		■	■
		S		■	■
	32	H		■	■
		R		■	■
		C		■	■
	40	S		■	■
		H		■	■
		R		■	■
50	C		■	■	
	S		■	■	
	H		■	■	
60	R		■	■	
	C		■	■	
	S		■	■	
63	H		■	■	
	R		■	■	
	C		■	■	
75	S		■	■	
	H		■	■	
	R		■	■	

Frame level	Current (A)	Breaking capacity code	Front connection screw		
			Hexagonal head screw (A)	Hexagonal socket screw (B)	Cross screw (C)
125	80	C		■	■
		S		■	■
		H		■	■
	100	R		■	■
		C		■	■
		S		■	■
	125	H		■	■
		R		■	■
		C		■	■
	100	S		■	
		H		■	
		R		■	
	125	S		■	
		H		■	
		R		■	
	140	S		■	
		H		■	
		R		■	
150	S		■		
	H		■		
	R		■		
160	S		■		
	H		■		
	R		■		
175	S		■		
	H		■		
	R		■		
180	S		■		
	H		■		
	R		■		
200	S		■		
	H		■		
	R		■		
225	S		■		
	H		■		
	R		■		
250	S		■		
	H		■		
	R		■		
225	S	■	■		
	H	■	■		
	R	■	■		
250	S	■	■		
	H	■	■		
	R	■	■		
250	S	■	■		
	H	■	■		
	R	■	■		
300	S	■	■		
	H	■	■		
	R	■	■		



Frame level	Current (A)	Breaking capacity code	Front connection screw		
			Hexagonal head screw (A)	Hexagonal socket screw (B)	Cross screw (C)
315		S	■	■	
		H	■	■	
		R	■	■	
400	350	S	■	■	
		H	■	■	
		R	■	■	
400	400	S	■	■	
		H	■	■	
		R	■	■	
400	400	S		■	
		H		■	
		R		■	
450	450	S		■	
		H		■	
		R		■	
630	500	S		■	
		H		■	
		R		■	
630	630	S		■	
		H		■	
		R		■	
630	630	H		■	
		R		■	
		R		■	
800	700	H		■	
		R		■	
		R		■	
800	800	H		■	
		R		■	
		R		■	

Cage clamp terminals (for products 16~400A, cage clamp terminals are available)

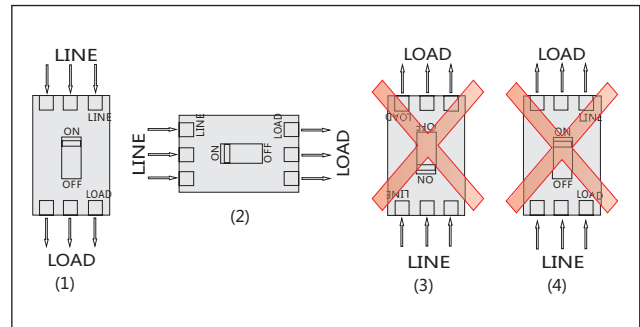
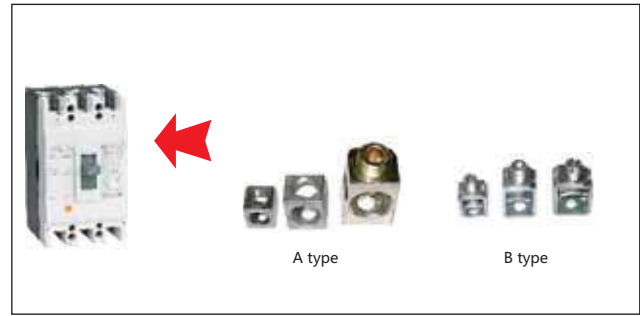

Modes of down-lead (1) and (2) illustrated in the figure are available for your wiring operation. For its breaking capacity may be affected, mode of down-lead (3) is not recommended, before reception of any authorized announcement from the manufacturer; the mode of down-lead (4) is prohibited for your wiring.

10. Overall and mounting dimensions

Fig.15a NM1-63, 125, 250 fixed connection

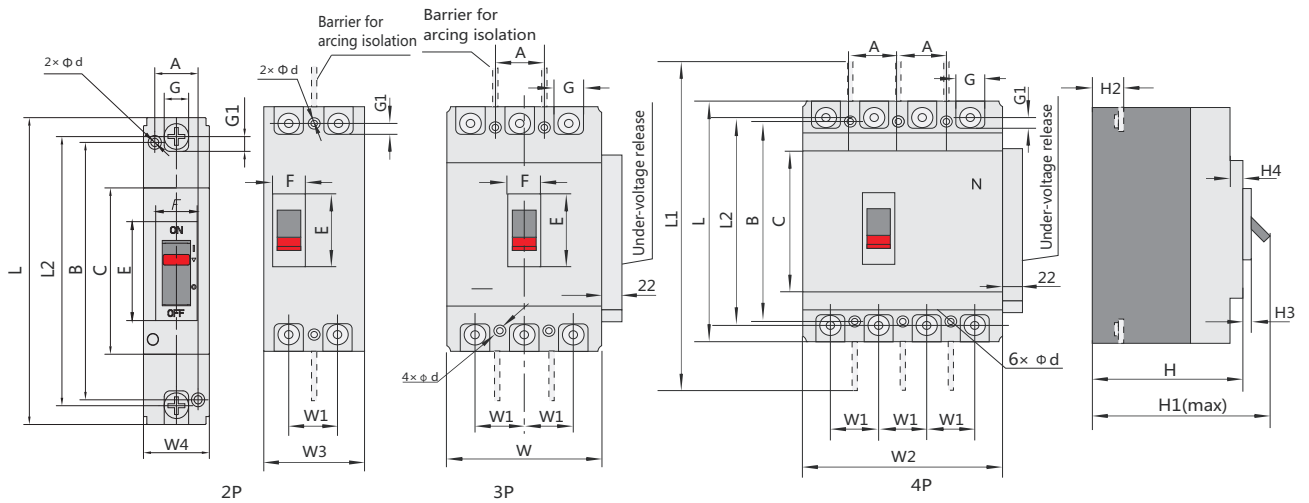

(mm)

Dimension		NM1-63S	NM1-63H	NM1-125C NM1-125S	NM1-125H NM1-125R	NM1-250S/1P	NM1-250S	NM1-250H NM1-250R
Overall dimensions	C	85	85	85	85	102	102	102
	E	48	48	51	51	51	51	51
	F	23	23	23	23	22	23	23
	G	14	14	17.5	17.5	23	23	23
	G1	6.5	6.5	7.5	7.5	11.5	11.5	11.5
	H	70	80	67	86	86	87	103.5
	H1	91	100	86	104	109	110	127
	H2	19	28	24	24	24	24	24
	H3	6	6	4	4	4.5	3.5	3.5
	H4	5	5	7	7	6	5.5	5.5
	L	135	135	155	155	165	165	165
	L1	235	235	255	255	-	360	360
	L2	117	117	136	136	144	144	144
	W	76	76	90	90	-	105	105
	W1	25	25	30	30	-	-	35
	W2	-	103	-	120	-	-	140
W3	-	-	-	65	-	-	75	
W4	-	-	-	-	35	-	-	
Mounting dimensions	A	25	25	30	30	28	35	35
	B	117	117	130.5	130.5	109	126	126
dimensions	φd	4.5	4.5	4.5×6	4.5×6	3.5	5	5

Overall and mounting dimensions of NM1-400, 630, 800, 1250(Fixed type)

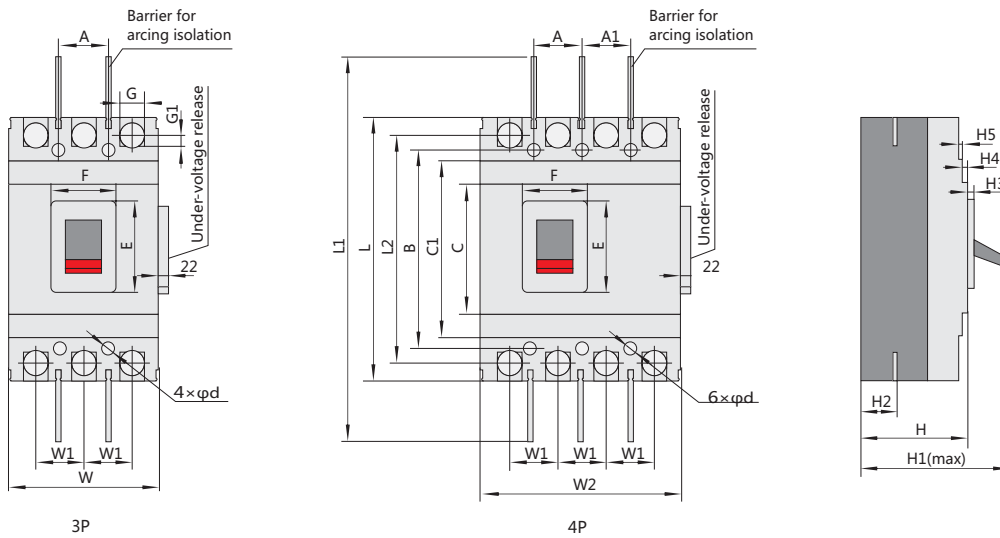

(mm)

Dimension	NM1-400S NM1-400H NM1-400R	NM1-630S NM1-630H NM1-630R	NM1-800H/R	NM1-1250H	
Overall dimensions	C	128	136	265.5	
	C1	174	184.5	345.5	
	E	89	89	81	100
	F	66	66	66	78
	G	31	40.5	45	-
	G1	12	15.5	12	-
	H	107	112	116	141
	H1	162	164.5	168	202
	H2	38	42	42	1250:56 ; 700A~1000A:54
	H3	6	6.5	4.5	19
	H4	5	3.5	5	2
	H5	4.5	4.5	8	4.5
	L	257	270.5	280	406*
	L1	459	472	490	715
	L2	224	234	243	-
	W	150	182	210	210
W1	48	58	70	70	
W2	198	240	280	-	
Mounting dimensions	A	44	58	70	
	A1	50	58	70	-
	B	194	200	243	375
	φ d	7	7	7	10

*Note: Length of NM1-1250H with the connection board, is 545mm

11. Accessories

Inner accessories



Accessory	Accessory code		Mounting and wiring mode		
	Magnetic only release	Compound release	NM1-125H,R NM1-250H,R	NM1-63S,H NM1-125C,S,H,R NM1-250S,H NM1-400S,H,R NM1-630S,H,R NM1-800H, R	NM1-1250H
			2P	3P 4P	3P
No accessory	200	300			
Alarm contact	208	308			
Shunt release	210	310			
Auxiliary contact	220	320			
Under-voltage release	230	330			
Shunt release, auxiliary contact	240	340			
Shunt release, under-voltage release	250	350			
Two groups of auxiliary contacts	260	360			
Auxiliary contact, under-voltage release	270	370			
Shunt release, alarm contact	218	318			
Auxiliary alarm contact	228	328			
Under-voltage release, auxiliary alarm contact	238	338			
Shunt release, auxiliary alarm contact	248	348			
Two groups auxiliary contact of auxiliary alarm contact	268	368			
Under-voltage release auxiliary alarm contact	278	378			

Note : ■ Shunt release ▲ Under-voltage release ○ Auxiliary contact ● Alarm contact



11.1 Under-voltage release

- a. $U_n=70\sim35\% U_s$, reliable operation
- b. $U_n < 35\% U_s$, prevent breaker from making
- c. $U_n > 85\% U_s$, guarantee the breaker making

The rated voltage of the under-voltage release is 50Hz, 230V and 400V.

Code of under-voltage release

code	A2	A4
voltage	AC 230V	AC 400V
rated frequency	50Hz	50Hz

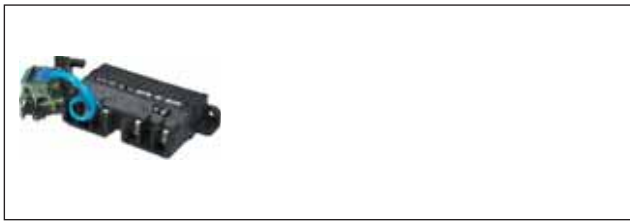

11.2 Shunt release

The rated control voltage of shunt release is 50Hz, 230V and 400V.

$U_n=70\%\sim110\% U_s$, reliable operation

Code of shunt release

code	A2	A4	D3
voltage	AC 230V	AC 400V	DC 24V
rated frequency	50Hz/ 60Hz	50Hz/ 60Hz	-

Note: when voltage is DC 24V, rated current should be up to $5A\pm10\%$

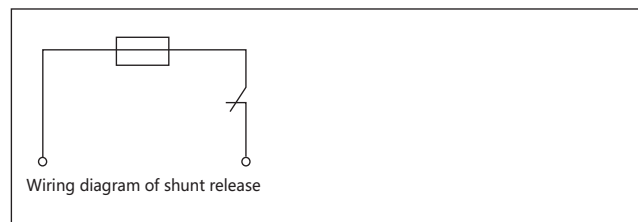

11.3 Auxiliary contact and alarm contact

Rated parameter of auxiliary contact

Frame size	Conventional heating current I_{th} (A)	Rated current I_e (A) at AC 400 V	Rated current I_e (A) at DC 230 V
$I_{nm} \leq 250A$	3	0.26	0.14
$I_{nm} \geq 400A$	6	3	0.2

a. Auxiliary contact

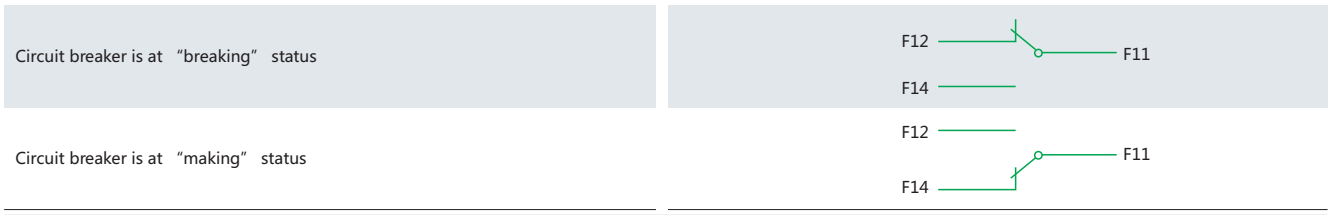

b. Alarm contact

When circuit breaker normally makes and breaks, alarm contact doesn't operate. After free release (or release due to failure) alarm contact operate; and after the circuit breaker operates again, alarm contact returns to the original status.

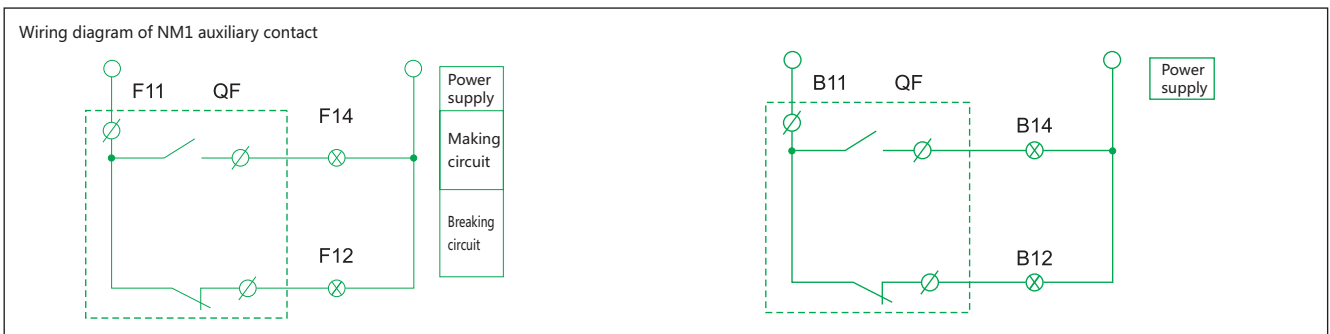
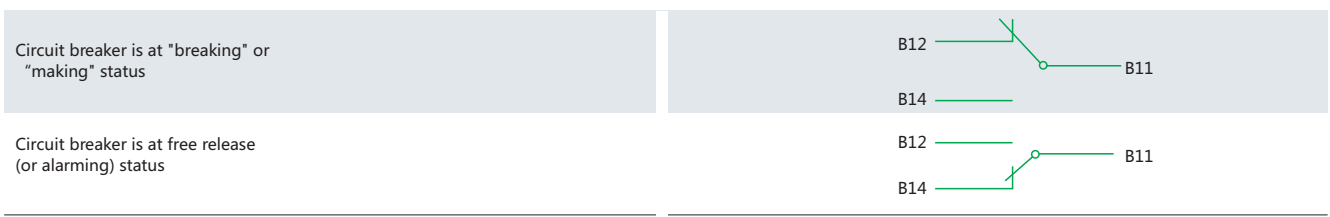

External accessories

11.4 Motor-driven operation mechanism

Items	Model	NM1-63 NM1-125, NM1-250, NM1-400, NM1-630, NM1-800, NM1-1250
Structure form		Motor
Code of AC/DC voltage		A1/D1, A2/D2, A4

Note: A1 AC 110V, A2 AC 230V, A4 AC 400V, D1 DC 110V, D2 DC 230V



Making and breaking diagram of motor-driven operation mechanism(AC/DC)

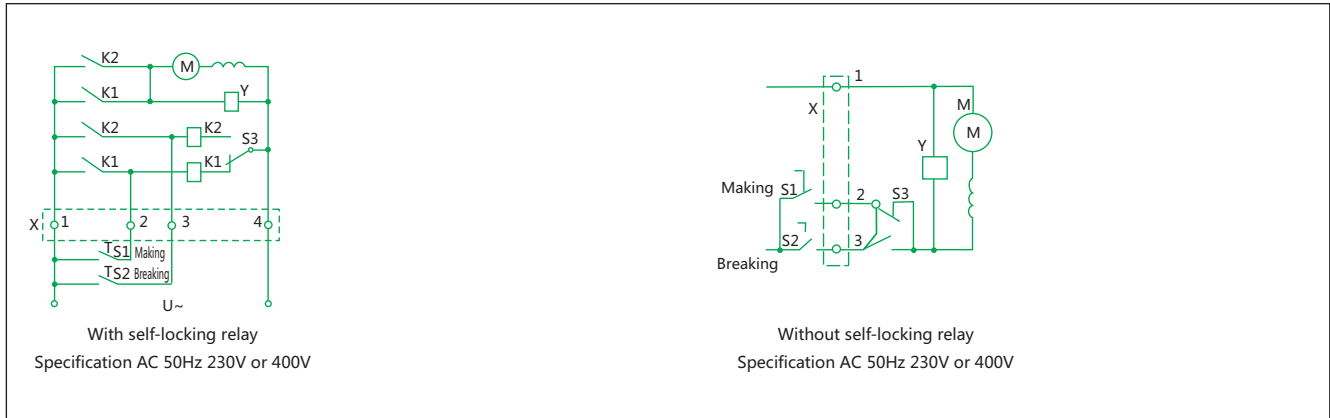

Rotary manual operation mechanism

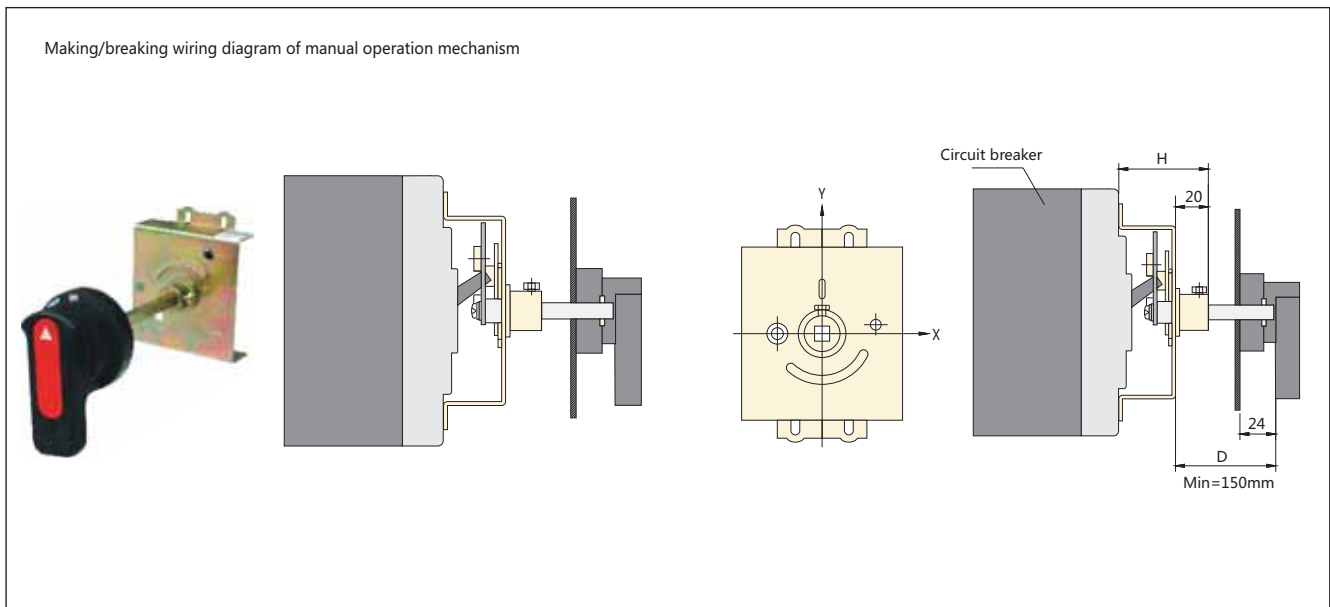

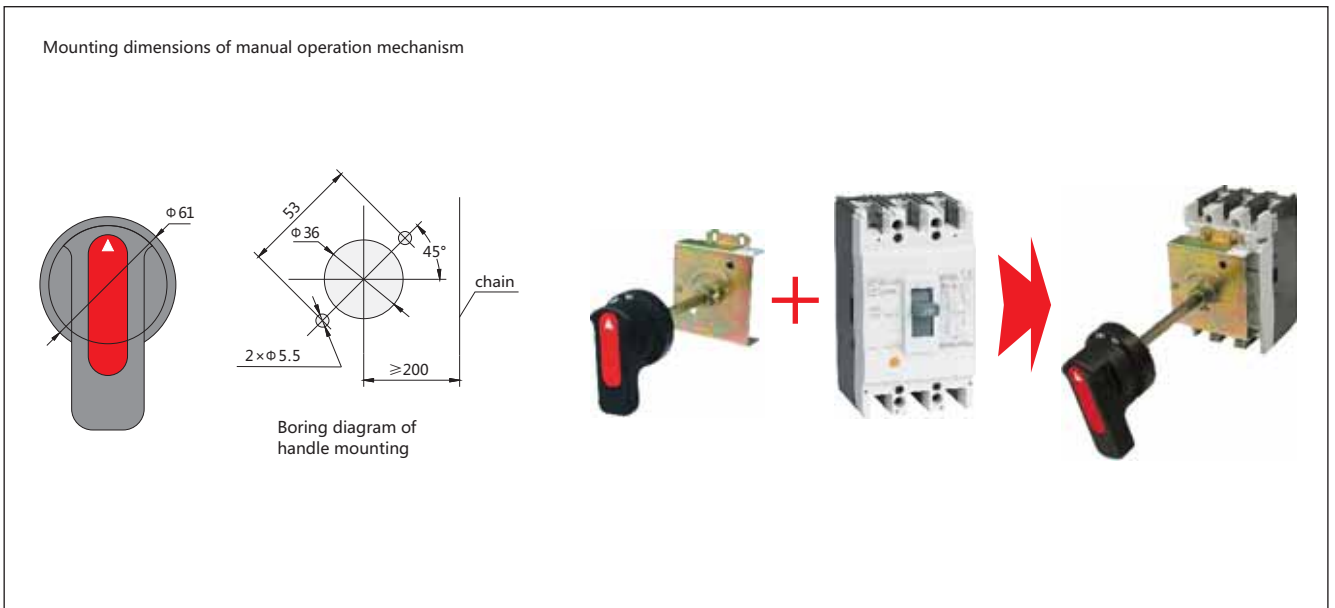

(mm)

Model	NM1-63	NM1-125	NM1-250	NM1-400	NM1-630	NM1-800H NM1-800R	NM1-1250S NM1-1250H
Mounting size H	51	51	54	88	89	96	83
Y value of the handle related to the center of the breaker	0	0	0	0	0	0	0



Mounting and boring dimensions

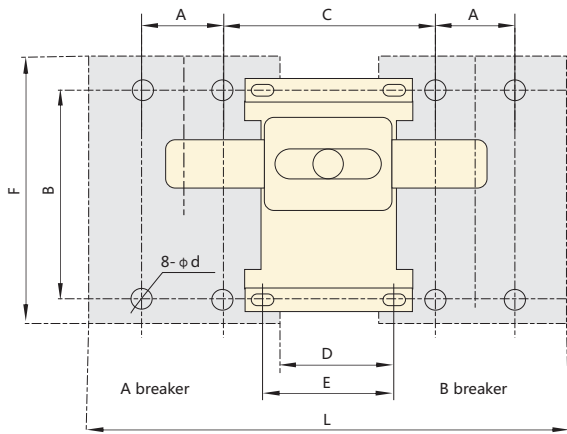

(mm)

Model	A	B	C	D	E	F	L	φd
NM1-63	25	117	80	30	80	135	182	4.5
NM1-125	30	130.5	90	30	90	155	210	4.5×6*
NM1-250	35	126	100	30	100	165	240	5.5
NM1-400	44	194	136	30	40	257	330	7
NM1-630	58	200	172	48	62	270	412	7
NM1-800	70	243	167	28	40	280	448	7

Note:

- * stands for length of boring.
- Install the breaker on the frame first, then install the mechanical interlock on the breaker.

12. Complementary technical information

- 12.1 The customized products of NM1-250, of which the capacity can be enriched to 250A is available.
- 12.2 NM1-1250 products are equipped with connection plate when they are sold; if you need connection plate for products of other model, the connection plate should be ordered separately.
- 12.3 Only H type breaker is applicable to manufacture NM1 series switch disconnecter.
- 12.4 Terminal covers of the whole series NM1 products are available, and the protection degree can be up to IP40 after the breaker is equipped with terminal cover.
- 12.5 Safe distance between other electric apparatuses for mounting.

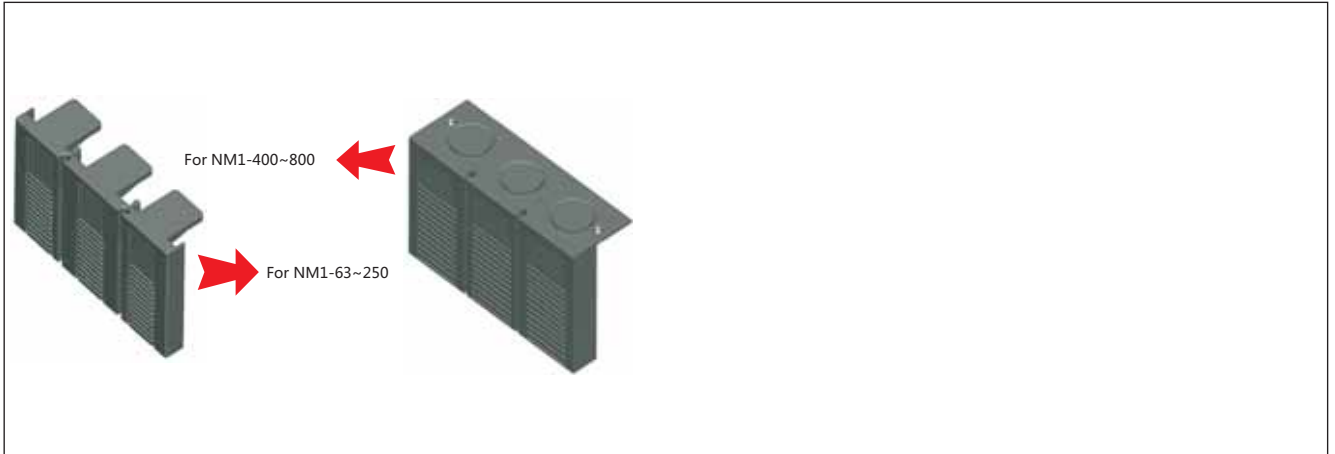

(mm)

Distance(min) \ Type	NM1-63	NM1-125	NM1-250	NM1-400	NM1-630	NM1-800	NM1-1250
Line side	50	50	50	100	100	100	100
Load side	20	20	20	20	20	20	20
Right side	25	25	25	25	25	25	25
Left side	25	25	25	25	25	25	25



12.6 Tightening torque table

Wire size(copper)		Rated current (A)	Tightening torque(N·m)	
AWG/MCM	mm ²		Front connection plate	Boxing terminal
16-6	1.5-16	10≤In≤63	5	3
4-3	25-50	63<In≤125	10	8
1-250	50-120	100<In≤250	12	10
250-500	120-240	250<In≤400	22	16
300×2	150×2	400<In≤500	28	18
350×2	185×2	500<In≤630	28	20
500×2	240×2	630<In≤800	30	-
350×4	185×4	800<In≤1250	30	-

12.7 Technical Data of NM1 series

Frame current (A)	Model	Number of poles	Ui (V)	Icu/Ics(kA)			
				220V 230V 240V	380V 400V 415V	660V 690V	
63	NM1-63S	3	500	20/10	15/7.5	-	
	NM1-63H	3/4	500	42/21	35/17.5	-	
125	NM1-125C	3	800	25/12.5	20/10	3/1.5	
	NM1-125S	3	800	42/21	25/12.5	3/1.5	
	NM1-125H	2	800	65/32.5	50/25	-	
		3/4	800	65/32.5	50/25	8/4	
	NM1-125R	3	800	85/42.5	65/32.5	10/5	
250	NM1-250S	1	800	20/10	10/5	-	
		3/4	800	42/21	25/12.5	5/2.5	
	NM1-250H	2	800	65/32.5	50/25	-	
		3/4	800	65/32.5	50/25	8/4	
	NM1-250R	3	800	85/42.5	65/32.5	10/5	
400	NM1-400S	3/4	800	50/25	35/17.5	10/5	
	NM1-400H	3	800	85/42.5	50/25	12/6	
	NM1-400R	3	800	100/50	70/35	15/7.5	
630	NM1-630S	3/4	800	50/25	35/17.5	12/6	
	NM1-630H	3	800	85/42.5	50/25	15/7.5	
	NM1-630R	3	800	100/50	70/35	20/10	
800	NM1-800H	3/4	800	85/42.5	60/30	20/10	
	NM1-800R	3	800	100/50	70/35	20/10	
1250	NM1-1250H	3	800	85/42.5	65/32.5	20/10	

Frame current (A)	Model	Number of poles	Ui (V)	Icu/Icm(kA)						
				220V	230V	240V	380V	400V	415V	660V
63	NM1-63S	3	500	20/40			15/30			-
	NM1-63H	3/4	500	42/88.2			35/73.5			-
125	NM1-125C	3	800	25/52.5			20/40			-
	NM1-125S	3	800	42/88.2			25/52.5			-
	NM1-125H	2	800	65/43			50/105			-
		3/4	800	65/43			50/105			-
	NM1-125R	3	800	85/187			65/143			-
250	NM1-250S	1	800	20/40			-			-
		2/ 3/4	800	42/88.2			25/52.5			-
	NM1-250H	2/ 3/4	800	65/136.5			50/105			-
	NM1-250R	3	800	85/187			65/143			-
400	NM1-400S	3/4	800	50/105			35/73.5			-
	NM1-400H	3	800	85/187			50/105			-
	NM1-400R	3	800	100/220			70/154			-
630	NM1-630S	3/4	800	50/105			35/73.5			-
	NM1-630H	3	800	85/187			50/105			-
	NM1-630R	3	800	100/220			70/154			-
800	NM1-800H	3/4	800	85/187			60/132			-
	NM1-800R	3	800	100/220			70/154			-
1250	NM1-1250H	3	800	85/187			65/143			-

Note: Parameters in black are only for your reference.



12.8 Cascading

12.8.1 Cascading (220/230/240V)

Upstream: NM1-63~1250

Downstream: DZ47, eB, UB, DZ158, DZ267, NB1, NBH8, NM1-63~1250

Upstream Breaking capacity (kA RMS)	Downstream							
	NM1-63S 20	NM1-63H 42	NM1-125S 25	NM1-125H 50	NM1-125R 65	NM1-250S 25	NM1-250H 50	
DZ267	20	40	20	35	50	20	25	
DZ47, eB, UB	20	40	20	35	50	20	25	
NBH8	20	40	20	35	50	20	25	
NB1(Icn=6000A)	20	42	25	35	50	25	35	
NB1(Icn=10000A)	20	42	25	40	50	25	35	
DZ158			25	40	50	25	40	
NM1-63S		42	25	50	65	25	50	
NM1-63H					65			
NM1-125S				50	65		50	
NM1-125H					65			
NM1-250S							50	
NM1-250H								
NM1-400S								
NM1-400H								
NM1-630S								
NM1-630H								
NM1-800H								
NM1-1250H								

12.8.2 Cascading (380/400/415V)

Upstream: NM1-63~1250

Downstream: DZ47, eB, UB, DZ158, DZ267, NB1, NBH8, NM1-63~1250

Upstream Breaking capacity (kA RMS)	Downstream							
	NM1-63S 15	NM1-63H 35	NM1-125S 25	NM1-125H 50	NM1-125R 65	NM1-250S 25	NM1-250H 50	
DZ47, eB, UB	10	15	10	15	15	10	15	
NB1(Icn=6000A)	15	20	15	20	20	15	20	
NB1(Icn=10000A)	15	20	20	25	25	20	25	
DZ158			20	25	35	20	25	
NM1-63S		35	25	50	65	25	50	
NM1-63H					65			
NM1-125S				50	65		50	
NM1-125H					65			
NM1-250S							50	
NM1-250H								
NM1-400S								
NM1-400H								
NM1-630S								
NM1-630H								
NM1-800H								
NM1-1250H								



NM1-250R 65	NM1-400S 35	NM1-400H 50	NM1-400R 70	NM1-630S 35	NM1-630H 50	NM1-630R 70	NM1-800H 60	NM1-800R 70	NM1-1250H 65
30									
30									
30									
35									
40									
50	30	40	50						
65									
65									
65		50	70		50	70	60	70	65
65			70			70		70	
65		50	70		50	70	60	70	65
65			70			70		70	
		50	70		50	70	60	70	65
			70			70		70	
					50	70			
						70			
								70	

NM1-250R 65	NM1-400S 35	NM1-400H 50	NM1-400R 70	NM1-630S 35	NM1-630H 50	NM1-630R 70	NM1-800H 60	NM1-800R 70	NM1-1250H 65
15									
20									
25									
35	20	25	35						
65									
65									
65		50	70		50	70	60	70	65
65			70			70		70	
65		50	70		50	70	60	70	65
65			70			70		70	
		50	70		50	70	60	70	65
			70			70		70	
					50	70			
						70			
								70	