

Ultrasonic sensors

OsiSense XX

Catalogue



Telemecanique
Sensors



Optimise detection with OsiSense XX

Detect all types of objects in all types of applications with **OsiSense™ XX** ultrasonic sensors. These ultrasonic sensors offer an efficient solution for reliable and high performance detection at distances of up to 8m, this being mainly due to the mode window*.

* The mode window enables suppression of the foreground and the background using the same sensor.

> A technology suited to your needs

Detection of all materials

> 3 modes for assuring efficient detection

Detection of all objects irrespective of shape

> Long distance proximity detection

Up to 50 mm for all types of objects

Contents

Customer benefits	pages 2 and 3
Selection guide based on application	pages 4 and 5
Product selection guide	pages 6 and 7
Ultrasonic sensors OsiSense XX	
General	pages 8 to 13
References/characteristics	pages 14 to 23
Accessories	page 24
Dimensions	pages 24 to 27
Connections	pages 28 and 29
Setting-up	pages 30 and 31
Product reference index	page 32

Simply easy!™ 

> A technology suited to your needs

Ultrasonic sensors enable detection, without contact, of any object in severe industrial environments, irrespective of its:

- material (metal, plastic, wood, cardboard, etc.),
- nature (solid, liquid, powder, paste, etc.),
- colour,
- degree of transparency.

The ultrasonic sensors are simple to install due to their integral connector and availability of cabling and fixing accessories.

100%

of materials detected in all applications

> 3 modes for assuring efficient detection

Diffuse mode

The object reflects the ultrasonic wave back to the sensor which, in turn, changes the output state.

Well suited to flat objects with their surface perpendicular to the ultrasonic beam.

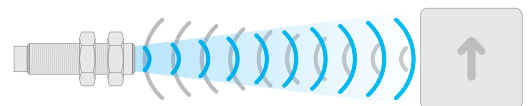

Reflex mode

The sensor is in a permanently detecting state on a fixed background of the machine and when the object to be detected breaks the ultrasonic beam the output changes state. Well suited to objects that absorb the ultrasonic wave (sponges etc.) or which do not reflect the wave back to the receiver (pointed objects or those with non perpendicular faces).

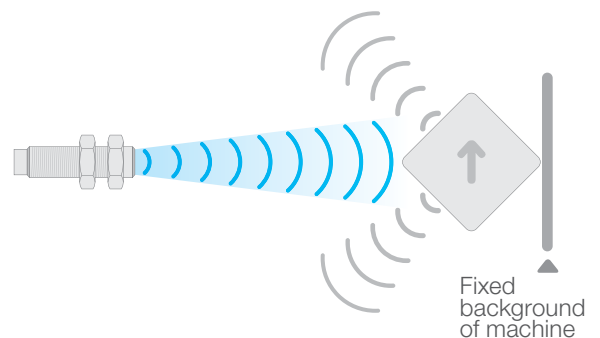

Thru-beam mode

The transmitter permanently transmits the ultrasonic wave to a receiver. The breaking of the ultrasonic beam by the presence of an object changes the output state of the receiver.

Well suited to the detection of small objects, accuracy and high switching frequencies.

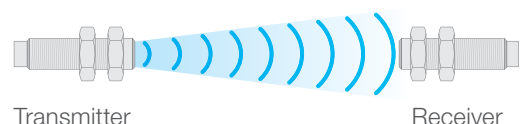

> Long distance proximity detection

The use of ultrasonic technology now makes it possible to obtain much longer detection distances. The new OsiSense XXV Ø18 ultrasonic sensors enable detection from 0 to 50 mm (i.e. 2.5 times more than standard products on the market) irrespective of the environment or object material and colour.

x 2,5
detection distance

In cases where detection distances for moving metal parts are very short, there is always a risk of the sensor being damaged on the slightest impact or knock. Increasing the detection distance of the moving metal parts assures safety of the sensor. Machine downtimes linked to incidents are reduced, as well as maintenance costs. You increase the profitability of your installations!

Osisense XXV Ø18

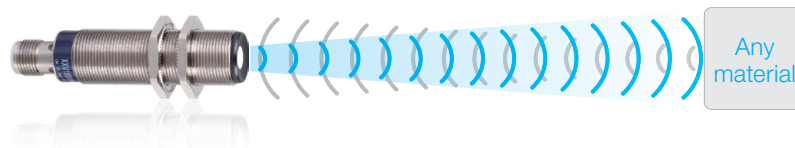

Standard product

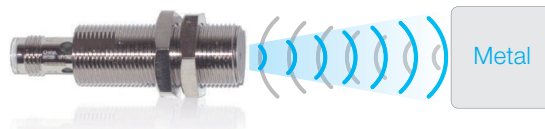

The OsiSense XXV ultrasonic sensor is "Plug and Play", no adjustment required, no teaching. Its solid-state output changes state when the object to be detected is less than 50 mm away.

The fineness and accuracy of its transmission angle enable only the desired object to be detected. Both mutual interference between sensors and edge effects are mastered

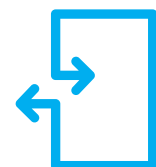

Plug & Play product



100%

Availability throughout the world

> Selection guide based on application

Type of detection

Detection "Digital"

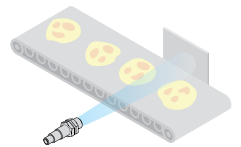
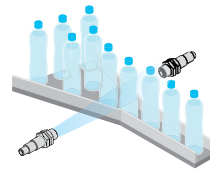
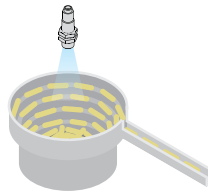

Assembly

Conveying

Machine part

Vibrating bowl

Presence
Absence

Transparent
bottles

Jam

Flow

Sensor type

Ø18
(M18x1)



Ø12
(M12x1)



Ø18
(M18x1)



Ø30
(M30x1,5)



7,6x19x33



16x30x74



18x33x60
Ø18
(M18x1)



80X80X34



Diffuse mode



Reflex mode

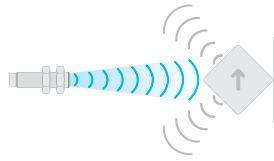

Thru-beam mode



Regulation "Analogue output"

Level monitoring

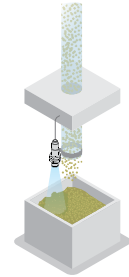
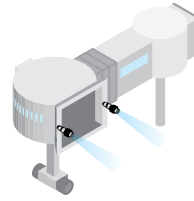
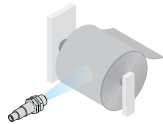
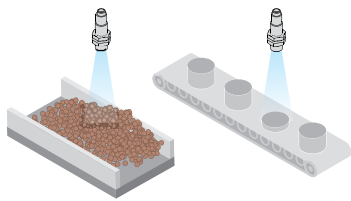
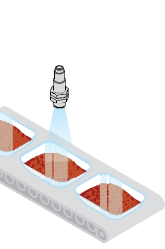

Packaging

Conveying

Packaging

Handling

Handling

Process

Transparent film

Material level

Height of part

Radius of strip roll

Height of elevating table

Aircraft boarding bridge

Monitoring 2 thresholds

Filling Emptying

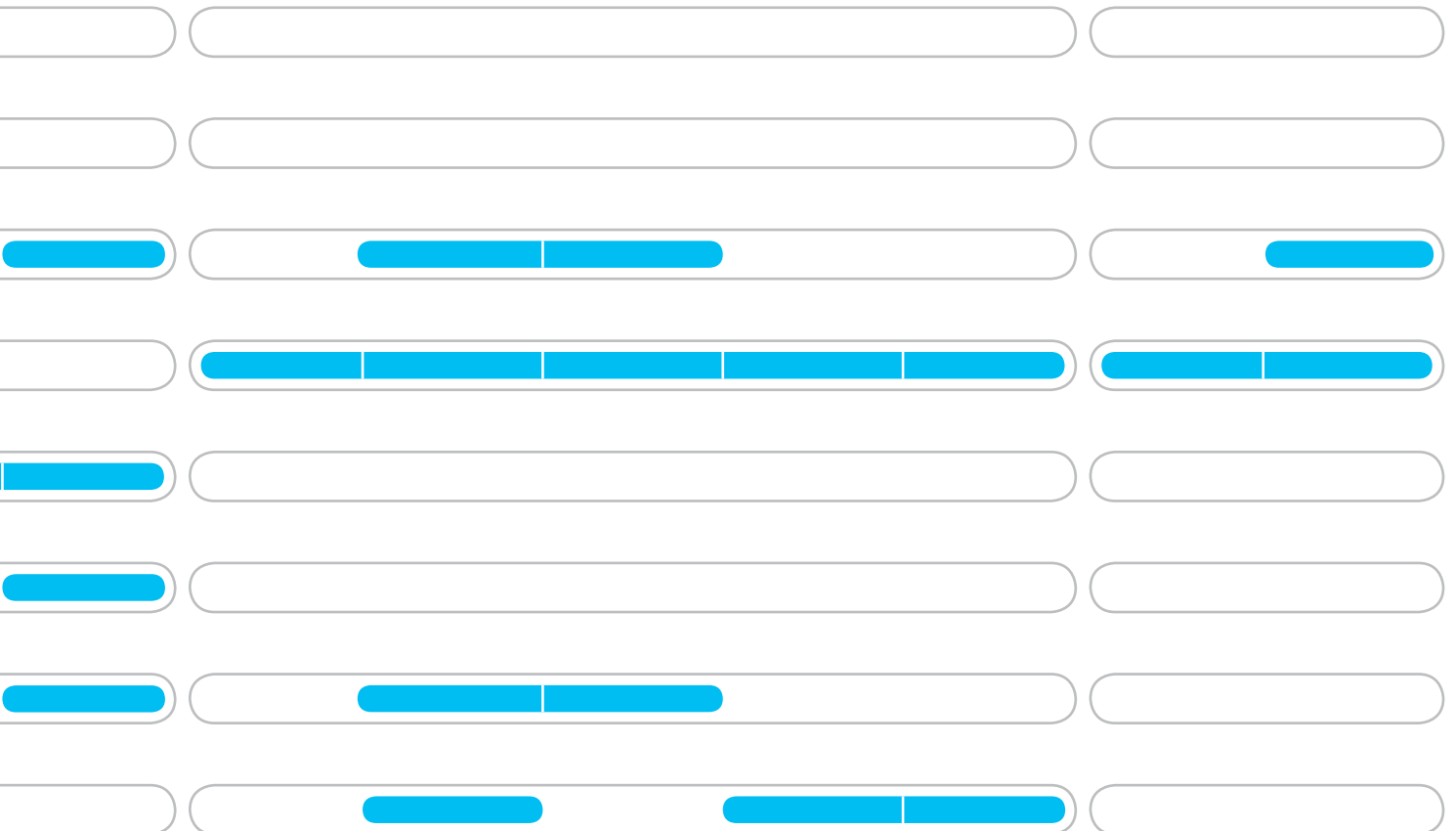

Applications
 Detection of any object, without physical contact, irrespective of: material (metal, plastic, wood, cardboard, etc.), nature (solid, liquid, powder, etc.), colour, degree of transparency, etc.

Dimensions (mm)

Sensors with solid-state digital output

Cylindrical type

Ø 12
(M12 x 1)



Ø 18
(M18 x 1)



Sensing distance Sn	Diffuse
	Reflex
	Thru-beam
Assured operating distance (mm)	6.4...51 fixed
Type of output	PNP/NPN
Degree of protection	IP 67
Function	NO
Connection	M8
Power supply	12...24 V $\overline{\text{---}}$ with protection against reverse polarity
Sensor type	XX5 12A1●
Pages	14

5 cm	10 cm	–	5 cm	15 cm	50 cm (adjustable)	–	–
–	–	–	–	–	50 cm (adjustable)	–	–
–	–	20 cm	–	–	–	61 cm	1 m
6.4...51 fixed	6.4...102 fixed	0...200 fixed	2...50 fixed	25...152 fixed	Adjustable using teach mode	Fixed	Fixed
PNP/NPN	NPN or PNP	PNP/NPN	PNP or NPN	PNP/NPN	NPN or PNP	PNP/NPN	PNP/NPN
IP 67	IP 67	IP 67	IP 67	IP 67	IP 67	IP 67	IP 67
NO	NO	NO/NC	NO NC	NO	NO	NO NC	NO NC
M8	M8	M8	M12 or pre-cabled	M12	M12 or pre-cabled (1)	M12	M12
XX5 12A1●	XX5 12A2●	XX●12 A8●	XXV 18B1●	XX5 18A1●	XX5 18A3● XXB 18A3●	XX●18 A3●	XX●18 A4●
14							

Dimensions (mm)

Sensors with analogue output

Cylindrical type

Ø 18 (M12 x 1)





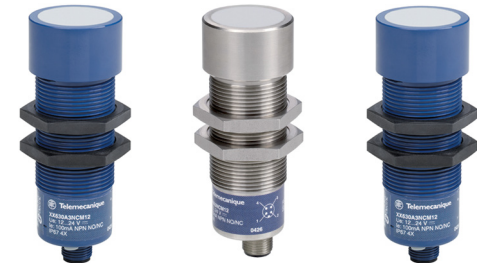



Ø 30 (M30 x 1.5)





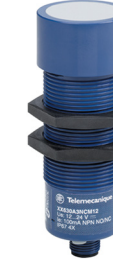

Sensing distance Sn	50 cm (adjustable)	1 m (adjustable)	2 m (adjustable)
Assured operating distance (mm)	Adjustable using teach mode	Adjustable using teach mode	
Type of output	4-20 mA/0-10 V	4-20 mA/0-10 V	
Degree of protection	IP 67	IP 65	
Connection	M12	M12	
Power supply	12...24 V $\overline{\text{---}}$ (2)	15...24 V $\overline{\text{---}}$ (2)	
Sensor type	XX918A3●	XX930A1●	XX930S1●
Pages	20		

XX918A3●	XX930A1●	XX930S1●	XX930A2●
20			

(1) XXB18A3●: M12 connector only. (2) With protection against reverse polarity.

			Cylindrical type		Flat format															
			Application, monitoring 2 levels																	
Ø 30 (M30 x 1.5)			Ø 18 (M18 x 1)	Ø 30 (M30 x 1.5)	7.6 x 19 x 33	16 x 30 x 74	18 x 33 x 60 + Ø 18 (M18 x 1)	80 x 80 x 34												
																				
1 m/2 m depending on model (adjustable)			8 m (adjustable)	50 cm	1 m/2 m dep. on model	10 cm	–	25 cm	–	50 cm (adjustable)	1 m (adjustable)									
–			1 m (adjustable)	–	–	–	–	–	–	50 cm (adjustable)	1 m (adjustable)									
–			–	–	–	–	20 cm	–	61 cm/1 m	–	–									
Adjustable using teach mode			Adjustable using teach mode		6.4...102 fixed	0...200 fixed	51...254 fixed	0...1000 fixed	Adjustable using teach mode											
PNP/NPN or NPN or PNP		PNP or NPN	PNP or NPN	PNP or NPN	PNP/NPN	NPN or PNP	NPN/PNP	NPN or PNP	NPN/PNP	NPN or PNP	NPN or PNP									
IP 65		IP 67	IP 65	IP 67	IP 67	IP 67	IP 67	IP 67	IP 67	IP 67	IP 67									
NO + NO or NO + NC		NO or NO + NC	NO + NC	NO	NO + NO	NO	NO NC	NO	NO + NO NC + NC	NO	NO									
M12		M12	M12	M12	M12	Connector on flying lead	M12	M12	M12	M12	M12									
12...24 V $\overline{\text{---}}$ with protection against reverse polarity																				
XX630A1● XX630A2● XX630S1●		XX6V3A1● XXBV3A1●	XX630A3●	XX218A3●	XX230A1● XX230A2●	XX7F1A2●	XX● F1A8●	XX7 K1A2●	XX● K1A3● XX● K1A4●	XX7 V1A1● XXB V1A1●	XX8 D1A1● XXB D1A1●									
14			22		18															

				Flat format											
Ø 30 (M30 x 1.5)				18 x 33 x 65 + Ø 18 (M18 x 1)				80 x 80 x 34							
															
1 m (adjustable)		8 m (adjustable)		50 cm (adjustable)		1 m (adjustable)									
Adjustable using teach mode				Adjustable using teach mode											
4-20 mA		0-10 V		4-20 mA		0-10 V		4-20 mA		0-10 V					
IP 67		IP 65		IP 67		IP 67		IP 67		IP 67					
M12		M12		M12		M12		M12		M12					
15...24 V $\overline{\text{---}}$ (2)				12...24 V $\overline{\text{---}}$ (2)				15...24 V $\overline{\text{---}}$ (2)							
XX9V3A1●		XX930A3●		XX9V1A1●		XX9D1A1●									
20															

Quality, standards and certifications

Quality control

The OsiSense XX ultrasonic sensors are subjected to special precautions in order to guarantee their reliability in the most arduous industrial environments.

- **Qualification**

A qualification procedure on the characteristics of OsiSense XX ultrasonic sensors is carried out in our laboratories.

- **Production**

The electrical characteristics, sensing distances at the ambient temperature and operating temperatures are 100% verified.

Sensors are statistically selected during the course of production and subjected to **monitoring tests** on all qualified characteristics.

- **Customer returns**

Returned ultrasonic sensors are subjected to systematic analysis and corrective actions are implemented to eliminate recurrence of the fault.

Conformity to standards

The OsiSense XX ultrasonic sensors conform to the standards IEC 60947-5-2.
Standards and characteristics: refer to pages 17, 19, 21 and 23.

Resistance to chemicals in the environment

To ensure lasting efficient operation, it is essential that any chemicals coming into contact with the ultrasonic sensors will not affect their casing and, in doing so, prevent their reliable operation.

Due to the materials used, OsiSense XX ultrasonic sensors are very resistant to:

- **Chemical agents:**

salts, aliphatic and aromatic oils,
petroleum, diluted bases and acids.

Depending on their nature and concentration, tests should be carried out beforehand for the following chemical agents:
alcohols, ketones and phenols.

- **Food and beverage industry products:**

vegetable oils, animal fats,
fruit juices,
milk proteins, etc.

Resistance to the environment

- **IP 65:** protection against water jets.

Tested in accordance with IEC 60529: the device is subjected to water sprayed from a Ø 6.3 mm nozzle, at a flow rate of 12.5 litres/min for 3 min at a distance of 3 m.
No deterioration in either operating or insulation characteristics is permitted.

- **IP 67:** protection against the effects of immersion.

Tested in accordance with IEC 60529: the sensor is immersed for 30 minutes in 1 m of water.
No deterioration in either operating or insulation characteristics is permitted.

- **IP 69K:** protection against the effects of high pressure cleaning. Adherence to standard

DIN 40050 which stipulates that the product must withstand a water jet at a pressure of 90 bar and temperature of +80°C for 3 minutes.
No deterioration in either operating or insulation characteristics is permitted.

Recommendations

The ultrasonic sensors are designed for use in standard industrial applications involving presence detection. Since these sensors do not incorporate a redundant electrical circuit, they are not suitable for use in safety applications. For safety applications, please refer to our "Safety functions and solutions using Preventa" catalogue.

Principle of ultrasonic detection

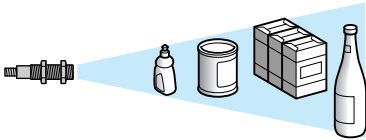

Presentation

Ultrasonic sensors enable detection, without contact, of any object irrespective of its:

- material (metal, plastic, wood, cardboard, etc.),
- nature (solid, liquid, powder, etc.),
- colour,
- degree of transparency.

They are used in industrial applications for detecting, for example:

- the position of machine parts,
- the presence of the windscreen during automobile assembly,
- the flow of objects on a conveyor system: glass bottles, cardboard packages, cakes, etc.,
- the level
- of different colour paints in pots,
- of plastic pellets in injection moulding machine feeders.

The ultrasonic sensors are simple to install due to their integral connector and availability of cabling and fixing accessories.

Operating principle

The principle of ultrasonic detection is based on measuring the time taken between transmission of an ultrasonic wave (pressure wave) and reception of its echo (return of transmitted wave).

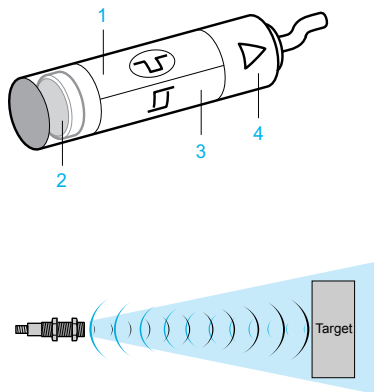

OsiSense XX ultrasonic sensors comprise:

- 1 a high voltage generator
- 2 a piezoelectric transducer (transmitter and receiver)
- 3 a signal processing stage
- 4 an output stage

Excited by the high voltage generator 1, the transducer (transmitter-receiver) 2 generates a pulsed ultrasonic wave (200 to 500 kHz depending on the product) which travels through the ambient air at the speed of sound. When the wave strikes an object, it reflects (echo) and travels back towards the transducer. A micro controller 3 analyses the signal received and measures the time interval between the transmitted signal and the echo. By comparison with the preset or taught times, it determines and controls the output states 4.

The output stage 4 controls a solid-state switch (PNP or NPN transistor) corresponding to a NO or NC contact (detection of object).

Advantages of ultrasonic detection

- No physical contact with the object to be detected, therefore, no wear and detection possible of fragile and/or freshly painted objects, etc.
- Detection of any material, irrespective of colour, at the same distance, without adjustment or correction factor.
- Teach mode function, by simply pressing a button, for defining the effective detection zone. Teaching of the minimum and maximum sensing distances (very precise foreground and background suppression, ± 6 mm).
- Very good resistance to industrial environments (robust products entirely encapsulated in resin).
- Solid-state units: no moving parts in the sensor, therefore, service life independent of the number of operating cycles.
- Various types of outputs to suit requirements:
 - Digital output for level control or detection of any type of object
 - Analogue output for controlling systems that require a signal that is proportional to the distance at which the object is detected.

Terminology

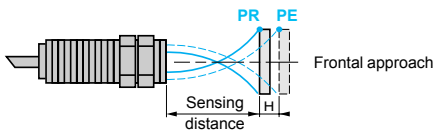
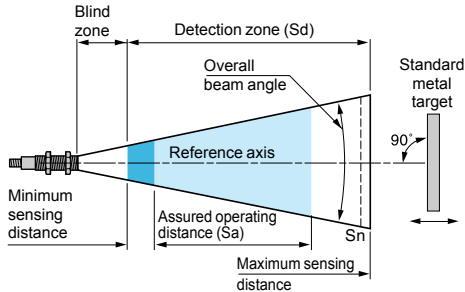

PR = drop-out point
PE = pick-up point

Definitions

The terms listed below are defined by the standard IEC 60947-5-2:

■ **Nominal sensing distance (Sn)**

Conventional value for indicating the sensing distance. It does not take into account manufacturing tolerances nor variations caused by external conditions such as voltage and temperature.

■ **Detection zone (Sd)**

Zone in which the sensor is sensitive to objects.

■ **Minimum sensing distance**

Lower limit of the specified detection zone.

■ **Maximum sensing distance**

Upper limit of the specified detection zone.

■ **Assured operating distance (Sa)**

This corresponds to the operating zone of the sensor (activation of outputs), and is included in the detection zone. It is also known as the "detection window".

Its limits are fixed:

- at the factory for fixed sensing distance sensors,
- when setting-up within the application for sensors with teach mode.

■ **Blind zone:** Zone located in front of the sensing face of the sensor.

For diffuse sensors, it is the zone in which the object will not be reliably detected.

For reflex sensors, it is the zone in which the target (fixed background of machine for example) will not be reliably detected, but the object can be in this zone.

For thru-beam sensors, there is no blind zone.

■ **Differential travel**

The differential travel (H) or hysteresis is the distance between the pick-up point as the standard metal target moves towards the sensor and the drop-out point as it moves away from the sensor.

■ **Repeat accuracy**

The repeat accuracy (R) is the precision of reproduction between two successive measurements of the sensing distance, made in identical conditions.

■ **Overall beam angle**

Fixed angle around the reference axis of an ultrasonic proximity sensor.

■ **Standard metal target**

The standard IEC 60947-5-2 defines the standard target as a square metal plate, 1 mm thick with rolled finish, placed perpendicularly to the reference axis.

Its side dimension depends on the detection zone:

Detection zone (mm)	Size of target (mm)
< 300	10 x 10
300 < d < 800	20 x 20
> 800	100 x 100

■ **Voltage drop (Ud)**

The voltage drop (Ud) corresponds to the voltage at the terminals of the sensor when in the closed state (value measured at the nominal current of the sensor).

■ **First-up delay**

Time required to ensure operation of the sensor's output signal following power-up.

- 1 Power-up
- 2 Output signal state (0 or 1)







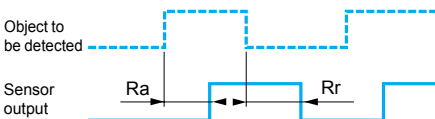
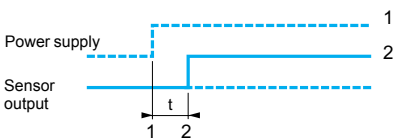
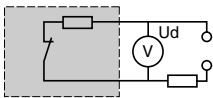





■ **Response time**

Response time (Ra): time taken between the instant the object to be detected enters the active zone and the changing of the output signal state. This time limits the passing speed of the target in relation to its dimensions.

Recovery time (Rr): time taken between the object being detected leaving the active zone and the changing of the output signal state. This time limits the interval between 2 objects.



Digital outputs

	NO output	NC output
No object present		
Diffuse mode	LED 	
Thru-beam mode	Output state 	
Reflex mode		
Object present		
Diffuse mode	LED 	
Thru-beam mode	Output state 	
Reflex mode		

(1) Fixed background of machine
(2) Object

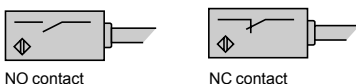

LED indicators

The majority of OsiSense XX ultrasonic sensors incorporate light-emitting diode output state indicators.

- Ø 12 sensor
 - Green LED (power on)
 - Yellow LED (object present)
- Ø 18 sensor, sensitivity 500 mm (except thru-beam versions XXT18 and XXR18)
 - Yellow LED (object present) or green LED (power on) + user assistance when adjusting the detection zone
- Ø 30 sensor
 - Multicolour LED for assisting the user when adjusting the detection distance
 - Yellow LED (object present)
 - Analogue version with LED (object present, with luminosity increasing as output signal increases)
- Parallelepiped format sensor
 - XX●F: Dual colour yellow (object present) or green (power on) LED
 - XX●V: Dual colour yellow (object present) or green (power on) LED + user assistance when adjusting the detection zone
 - XX7K: Yellow LED (object present); green LED (power on)
 - XXTK, XXRK: Yellow LED (object present) only
 - XX●D: Yellow LED (object present); green LED (power on)
 - Analogue version with LED (object present, with luminosity increasing as output signal increases)

Sensors with digital switching

Output contact logic

- NO contact (normally open)
Corresponds to a sensor whose output changes to the closed state when an object is present in the detection window.
- NC contact (normally closed)
Corresponds to a sensor whose output changes to the open state when an object is present in the detection window.

4-wire technique

NO output/PNP and NPN

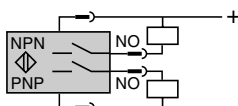

NO + NC output/NPN

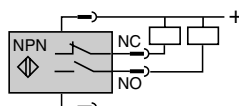

NO + NC output/PNP

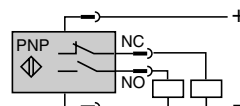

These sensors comprise 2 wires for the supply and 1 wire for each output signal

3-wire technique

NO output/NPN

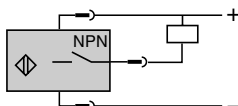

NO output/PNP

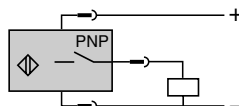

These sensors comprise 2 wires for the supply and 1 wire for the output signal,

- PNP type:** switching the positive side to the load.
- NPN type:** switching the negative side to the load.

Sensors with analogue output

Operation

The characteristic feature of these sensors is the output which delivers a signal (either current or voltage) that is proportional to the distance of the object being detected. Within the detection limits, which are adjustable using teach mode, the value of the output signal increases or decreases in relation to the distance of the object. When an object is detected, an LED indicator (D) illuminates and its luminosity increases in relation to the value of the output signal. The slope of the signal can simply be changed by pressing the teach button

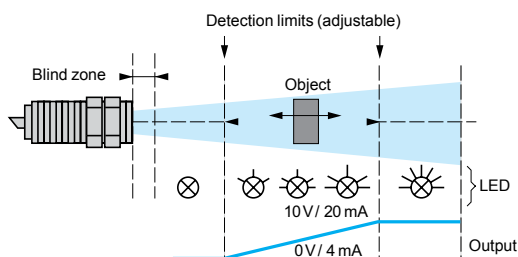

Advantages

- Visual information available relating to the sensor/object distance.
- Protection against reverse polarity.
- Protection against overloads and short-circuits.
- No residual current, low voltage drop.

Power supply

Sensors for DC circuits

- **DC source:** Check that the voltage limits of the sensor and the acceptable level of ripple, are compatible with the supply used.
- **AC source** (comprising transformer, rectifier, smoothing capacitor): The supply voltage must be within the operating limits specified for the sensor.

Where the voltage is derived from a single phase AC supply, the voltage must be rectified and smoothed to ensure that:

- the peak voltage of the DC supply is lower than the maximum voltage rating of the sensor.
- Peak voltage = nominal voltage $\times \sqrt{2}$
- the minimum voltage of the supply is greater than the minimum voltage rating of the sensor,

given that:

$$\Delta V = (I \times t) / C$$

$$\Delta V = \text{max. ripple: } 10\% (V),$$

I = anticipated load current (mA),

t = period of 1 cycle (10 ms full-wave rectified for a 50 Hz supply frequency),

C = capacitance (μF).

As a general rule, use a transformer with a lower secondary voltage (U_e) than the required DC voltage (U).

Example:

18 V \sim to obtain 24 V \dots ,

36 V \sim to obtain 48 V \dots .

Setting-up precautions

For diffuse sensors:

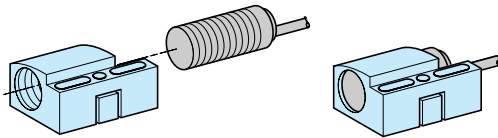
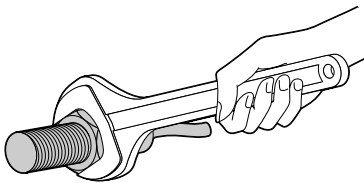
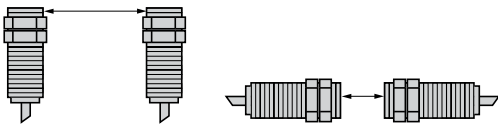

XSZB1●●

Mounting

Mounting distance between ultrasonic sensors

If 2 standard sensors are mounted too close to each other, the wave transmitted by one sensor is likely to interfere with the other and result in erratic operation.

In order to avoid this, it is necessary to adhere to the minimum distances between sensors. See setting-up precautions on page 30.

Maximum tightening torque

Cylindrical sensors	Diameter mm	Tightening torque	Flat sensors	Screw	Tightening Torque
XX●12●	Ø 12	0.7 N.m/ 0.52 lb-ft	XX●F●	M3	0.7 N.m/ 0.52 lb-ft
XX●18●	Ø 18	1 N.m/ 0.74 lb-ft	XX●K●	M4	1 N.m/ 0.74 lb-ft
XX●30●	Ø 30	1.35 N.m/ 1 lb-ft	XX●V●	M3	0.7 N.m/ 0.52 lb-ft
XX●V3●	Ø 30	1.35 N.m/ 1 lb-ft		Ø 18	1 N.m/ 0.74 lb-ft

Interchangeability

Interchangeability is made easy by using **indexed** fixing clamps:

- XSZB112 (Ø 12 mm),
- XSZB118 (Ø 18 mm),
- XSZB130 (Ø 30 mm).

Cabling

Electrical connection

- **Connect the sensor before switching on the supply**

- **Length of cable**

No limitation up to 200 m or up to a line capacitance of < 0.1 μF .

It is, however, advisable to take into account the voltage drop on the line.

- **Separation of control and power cables**

The sensors are immune to electrical interference encountered in normal industrial conditions.

Where extreme conditions of electrical "noise" could occur (large motors, spot welders, etc.),

it is advisable to protect against transients in the normal way:

- suppress interference at source,
- separate power and control wiring from each other,
- smooth the supply,
- limit the length of cable.

Setting-up precautions (continued)

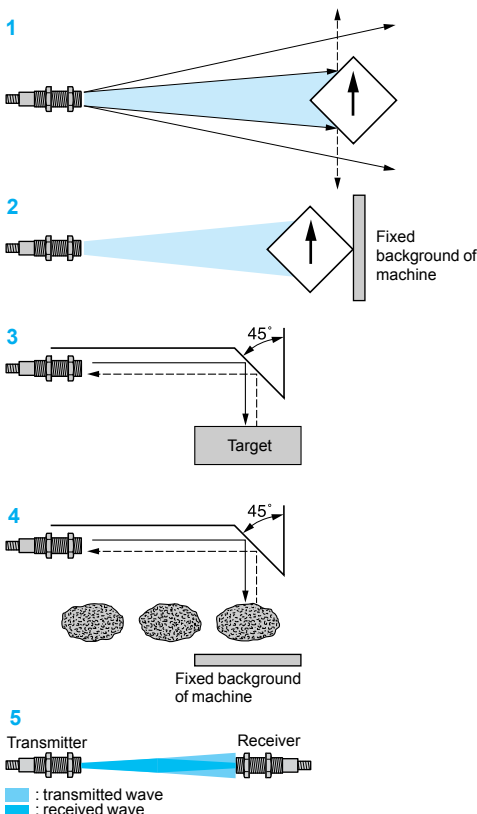
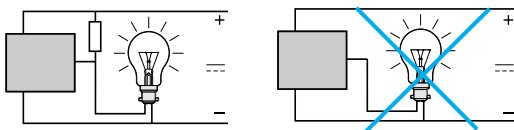
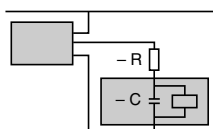
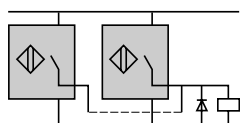
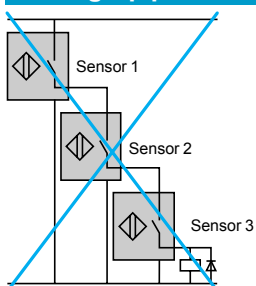

Connection in series

This connection method is not recommended.

- Correct operation of the sensors cannot be assured and, if this method is used, tests should be made before installation.

The following points should be taken into account:

Sensor 1 carries the load current in addition to the no-load current consumption values of the other sensors connected in series. For certain models, this connection method is not possible unless a current limiting resistor is used.

When in the closed state, each sensor will produce a voltage drop and, therefore, the load voltage should be selected accordingly.

As sensor 1 closes, sensor 2 will not operate until a certain time "T" has elapsed (corresponding to the first-up delay) and likewise for the following sensors in the sequence.

"Flywheel" diodes should be used when the load being switched is inductive.

Sensors and units in series with an external mechanical contact

- The following points should be taken into account:

When the mechanical contact is open, the sensor is not supplied.

When the contact closes, the sensor will not operate until a certain time "T" has elapsed (corresponding to the first-up delay).

Connection in parallel

- No specific restrictions. The use of "flywheel" diodes is recommended when an inductive load (relay) is being switched.

Capacitive load (C > 0.1 mF)

- At switch-on, it is necessary to limit (by resistor) the charging current of the capacitive load C. The voltage drop in the sensor can also be taken into account by subtracting it from the supply voltage for calculation of R.

$$R = \frac{U \text{ (supply)}}{I \text{ max. (sensor)}}$$

Load comprising an incandescent lamp

- If the load comprises an incandescent lamp, the cold state resistance can be 10 times lower than the hot state resistance. This can cause very high current levels on switching. Fit a pre-heat resistance in parallel with the sensor.

$$R = \frac{U^2}{P} \times 10, U = \text{supply voltage and } P = \text{lamp power}$$

Detection

Influencing factors

The ultrasonic sensors are particularly suited for the detection of objects that are capable of reflecting an acoustic wave and, in general, having a flat surface perpendicular to the detection axis. However, the correct operation of the ultrasonic sensor can be disrupted by:

- air currents, which can accelerate or divert the acoustic wave transmitted by the sensor (ejection of part by air jet),
- high temperature gradients within the detection zone: an object emitting considerable heat can create zones of varying temperature that will modify the propagation time of the wave and thus prevent reliable operation,
- sound insulators: sound absorbing materials (cotton, fabrics, rubber, etc.),
- the angle between the face of the object to be detected and the reference axis of the sensor: when the angle is offset from 90°, the wave is no longer reflected back along the sensor axis and the operating distance is reduced. The greater the distance between the sensor and the target, the greater the effect. Detection is not possible when the angle exceeds $\pm 10^\circ$.
- the shape of the object to be detected: similar to the example above, an excessively angular object can be difficult to detect 1. In this case, use reflex mode detection.

Detection systems

Diffuse mode

In this mode, it is the object itself that reflects the ultrasonic wave back to the sensor which, in turn, switches its output. It is the most widely used and the most simple mode. In this mode, the object will not be detected in the blind zone.

Reflex or beam break mode

The sensor is in a permanently detecting state on a fixed background of the machine and when the object to be detected breaks the acoustic beam the output switches state 2. This mode is particularly recommended in cases where the shape of the object changes (irregular, angular, non perpendicular) and also for objects that absorb sound (see above). This mode can be achieved by using a diffuse mode sensor (with background teaching) or, more simply, by using a ready to use reflex mode sensor.

In cases where space is restricted, a reflector 3 and 4, angled at 45°, can be used. This system can be used for both the diffuse and reflex modes. This reflector can be a flat part of the machine or a separate element. In this mode, the background of the machine must not be within the blind zone. But if the object is within this zone, it will be reliably detected.

Thru-beam mode

Detection is achieved using both a transmitter and receiver, with the transmitter permanently transmitting an acoustic wave to the receiver. The breaking of the beam by the presence of an object switches the output of the receiver. This mode provides long detection distances 5. In this mode there is no blind zone.

Ultrasonic sensors

OsiSense XX, General purpose
Cylindrical, plastic or metal
DC supply, solid-state output

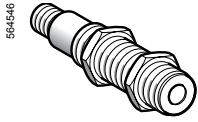

XX512A1KAM8

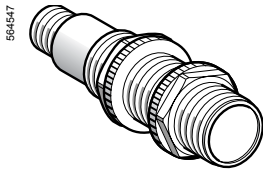

XX518A1KAM12

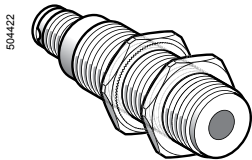

XXV18B1M12

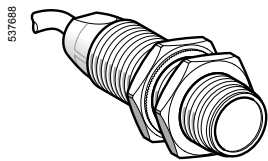

XX518A3L2

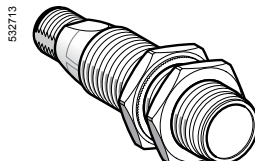

XX518A3AM12

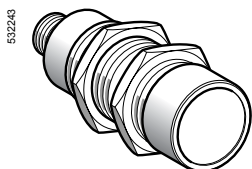

XX630A1M12
XX630A2M12

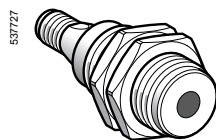

XX6V3A1AM12

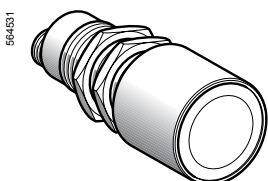

XX630A3CM12

Diffuse system

Fixed sensing distance sensors

Sensors	Sensing distance (Sn) m	Function/output	Connection	Reference	Weight kg		
Ø 12 Plastic	0.05	NO/PNP + NO/NPN	M8 connector	XX512A1KAM8	0.011		
	0.10	NO/NPN	M8 connector	XX512A2NAM8	0.011		
		NO/PNP	M8 connector	XX512A2PAM8	0.011		
Ø 18 Plastic	0.15	NO/PNP + NO/NPN	M12 connector	XX518A1KAM12	0.033		
Ø 18 Metal	0.05	NO/NPN	Pre-cabled (L = 2 m)	XXV18B1NAL2	0.110		
			Pre-cabled (L = 5 m)	XXV18B1NAL5	0.200		
			Pre-cabled (L = 10 m)	XXV18B1NAL10	0.340		
	M12 connector			M12 connector	XXV18B1NAM12	0.050	
				NO/PNP	Pre-cabled (L = 2 m)	XXV18B1PAL2	0.110
				Pre-cabled (L = 5 m)	XXV18B1PAL5	0.200	
	Pre-cabled (L = 10 m)			Pre-cabled (L = 10 m)	XXV18B1PAL10	0.340	
				M12 connector	XXV18B1PAM12	0.050	
				NC/NPN	Pre-cabled (L = 2 m)	XXV18B1NBL2	0.110
	Pre-cabled (L = 5 m)			Pre-cabled (L = 5 m)	XXV18B1NBL5	0.200	
				Pre-cabled (L = 10 m)	XXV18B1NBL10	0.340	
				M12 connector	XXV18B1NBM12	0.050	
NO/PNP			Pre-cabled (L = 2 m)	XXV18B1PBL2	0.110		
			Pre-cabled (L = 5 m)	XXV18B1PBL5	0.200		
			Pre-cabled (L = 10 m)	XXV18B1PBL10	0.340		
M12 connector			M12 connector	XXV18B1PBM12	0.050		

Adjustable sensing distance sensors

Ø 18 Plastic	0.50 (adjustable)	NO/NPN	Pre-cabled (L = 2 m)	XX518A3NAL2	0.080	
		NO/PNP	Pre-cabled (L = 2 m)	XX518A3PAL2	0.080	
		NO/NPN	M12 connector	XX518A3NAM12	0.033	
		NO/PNP	M12 connector	XX518A3PAM12	0.033	
Ø 30 Plastic	1 (adjustable)	NO/PNP + NO/NPN	M12 connector	XX630A1KAM12	0.090	
		NO/NPN	M12 connector	XX6V3A1NAM12	0.090	
		NO/PNP	M12 connector	XX6V3A1PAM12	0.090	
		NO/NPN + NC/NPN	M12 connector	XX630A1NCM12	0.090	
			M12 connector	XX630S1NCM12 (1)	0.090	
		NO/PNP + NC/PNP	M12 connector	XX630A1PCM12	0.090	
			M12 connector	XX630S1PCM12 (1)	0.090	
		2 (adjustable)	NO/NPN + NC/NPN	M12 connector	XX630A2NCM12	0.090
			NO/PNP + NC/PNP	M12 connector	XX630A2PCM12	0.090
		8 (adjustable)	NO/NPN + NC/NPN	M12 connector	XX630A3NCM12	0.110
NO/PNP + NC/PNP	M12 connector		XX630A3PCM12	0.110		

(1) Stainless steel 303 case.

Ultrasonic sensors

OsiSense XX, General purpose

Cylindrical, plastic or metal

DC supply, solid-state output

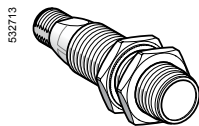

XXB18A3PAM12

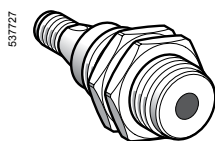

XXBV3A1PAM12

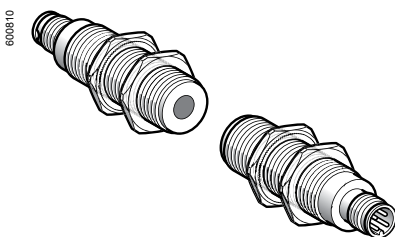

XXT18● + XXR18● (thru-beam system)



XXZPB100

Reflex system

Adjustable sensing distance sensors

Sensors	Sensing distance (Sn) m	Function/output	Connection	Reference	Weight kg
Ø 18 Plastic	0.50 (adjustable)	NO/PNP	M12 connector	XXB18A3PAM12	0.033
Ø 30 Plastic	1 (adjustable)	NO/PNP	M12 connector	XXBV3A1PAM12	0.090

Thru-beam system

Sensors	Sensing distance (Sn) m	Function/output	Connection	Reference	Weight kg
Ø 12					
Transmitter	0.20		M8 connector	XXT12A8M8	0.020
Receiver	0.20	NO/PNP + NO/NPN	M8 connector	XXR12A8KAM8	0.020
		NC/PNP + NC/NPN	M8 connector	XXR12A8KBM8	0.020
Ø 18					
Transmitter	0.61		M12 connector	XXT18A3M12	0.040
Receiver	0.61	NO/PNP + NO/NPN	M12 connector	XXR18A3KAM12	0.040
		NC/PNP + NC/NPN	M12 connector	XXR18A3KBM12	0.040
Transmitter	1		M12 connector	XXT18A4M12	0.040
Receiver	1	NO/PNP + NO/NPN	M12 connector	XXR18A4KAM12	0.040
		NC/PNP + NC/NPN	M12 connector	XXR18A4KBM12	0.040

Accessories

Teach pushbutton	For use with sensors	Reference	Weight kg
Selection of detection window Input: M12 female connector Output: M12 male connector	XX518A3●AM12, XXB18A3●AM12, XXBV3A1●AM12 and XX6V3A●AM12	XXZPB100	0.035

Other connection and fixing accessories

See page 24.

Ultrasonic sensors

OsiSense XX, General purpose

Cylindrical, plastic or metal

DC supply, solid-state output

Sensor type	XX5 12A1●	XX5 12A2●	XX● 12A8●	XXV 18B1●	XX5 18A1●	XX● 18A3●	XX5 18A3●	XX6 V3A1●	XX630A1● XX630A2● XX630S1●	XX6 30A3●	
General characteristics											
Conformity to standards	CE, IEC 60947-5-2										
Product certifications	UL	UL	UL	cULus		UL	UL, cCSAus (1)	UL, cCSAus (2)			
Nominal sensing distance (Sn)	m	0.05	0.1	0.2	0.05	0.15	0.60 or 1 (3)	0.50	1	1 or 2 (4)	8
Blind zone (in diffuse mode the object is not detected in this zone, in reflex mode the background is not detected in this zone)	mm	0...6.4	0...6.4	–	0...2	0...19	–	0 ... 51 (XX518A3●) 0 ... 165 (XXB18A3●)	0 ... 100 (XX6V3A1●) 0 ... 315 (XXBV3A1●)	0...51 (XX630●1 0...120 (XX630A2●)	0...300
Detection window	mm	Fixed						Remotely adjustable or by using external teach button		Adjustable using teach button on sensor	
Detection system	Diffuse	●	●	–	●	●	–	●	●	●	●
	Reflex	–	–	–	–	–	–	●	●	–	–
	Thru-beam	–	–	●	–	–	●	–	–	–	–
Transmission frequency (transmitter resonance)	kHz	500			360	200	300	300	180	200	75
Differential travel	mm	< 0.7	< 0.7	–	< 3	–	< 2.5	< 2.5	< 2.5	< 2.5	< 12.7
Repeat accuracy	mm	± 0.7		± 0.79	± 1.5	± 0.79	± 1.27	± 1.27	± 1.6	± 0.87	± 2.54
Overall beam angle (see detection lobe)		11°	10°	10°	10°	20	6°	6°	7°	10°	16°
Minimum size of object to be detected	Cylinder Ø (in mm), at distance (in mm)	Ø 2.5 at 38	Ø 2.5 at 50	Ø 12 at 200	Ø 2.5 at 20	Ø 1.6 at 63	Ø 38 at 600 Ø 114 at 1000	Ø 2.5 at 150	Ø 50 at 1000	Ø 1.6 at 635	Ø 51 at 4732
Deviation angle from 90° of the object to be detected		± 10°	± 10°	–	± 8°	± 10°	–	± 7°	± 5°	± 7° or ± 10° (4)	± 5°
Materials	Case	ULTEM®			Nickel plated brass	ULTEM®	ULTEM®	Valox®	Valox®	ULTEM®	ULTEM®
	Sensing face (5)	Epoxy			Epoxy	Silicone	Silicone	Epoxy	Epoxy	Silicone	Epoxy
Connection	Connector	M8, 4-pin	M8, 3-pin	M8, 4-pin	M12, 4-pin	M12, 4-pin	M12, 4-pin	M12, 4-pin	M12, 4-pin	M12, 4-pin	M12, 4-pin
	Pre-cabled (wire c.s.a.)	–	–	–	3 x 0.34 mm ² / AWG 22	–	–	4 x 0.08 mm ² /AWG 28	–	–	–

(1) Only XX518A3● sensors are cCSAus certified.

(2) Only XX6V3A1●, XX630A1●, XX630A2●, XX630S1● and XX630A3● sensors are cCSAus certified.

(3) The first value is given for XX●18A3●, the second value for XX●18A4●.

(4) The first value is given for XX630A1● and XX630S1●, the second value for XX630A2●.

(5) Silicone face for optimum chemical resistance.

Ultrasonic sensors

OsiSense XX, General purpose

Cylindrical, plastic or metal

DC supply, solid-state output

Sensor type		XX5 12A1●	XX5 12A2●	XX● 12A8●	XXV 18B1●	XX5 18A1●	XX● 18A3	XX5 18A3●	XX6 V3A1●	XX630A1● XX630A2● XX630S1●	XX6 30A3●	
Supply characteristics												
Rated supply voltage	V	12...24 V $\overline{\text{---}}$ with protection against reverse polarity										
Voltage limits (including ripple)	V	10...28 V $\overline{\text{---}}$			10...36 V $\overline{\text{---}}$	10...28 V $\overline{\text{---}}$						
Current consumption, no-load	mA	25		50	15	60	40	40	60	50 or 100 (1)	50	
Output characteristics												
LED indicators	Output state	Yellow LED				–	–	Yellow LED				
	Power on	Green LED				–	–	–	Green LED			
	Setting-up assistance	–	–	–	–	–	–	Multicolour LED				
Switching capacity (with overload and short-circuit protection)	mA	< 100			< 200	< 100						
Voltage drop	V	< 1 (NPN); < 1.5 (PNP); 1.1 for XX●12A8, < 2 for XXV18B1●; 0.5 for XX630A2●										
Maximum switching frequency	Hz	125	125	125	80	80	40	40	70	10 or 16 (1)	2	
Delays	First-up	ms	20	20	20	5	350	100	100	75	720	800
	Response	ms	2	3	0.4	4	3	10	10	15	20 or 25 (1)	200
	Recovery	ms	2	3	0.4	4	3	10	10	75	20	200
Environment characteristics												
Degree of protection	Conforming to IEC 60529 and IEC 60947-5-2	IP 67			IP 65, IP 67 or IP 69K (2)	IP 67	IP 67	IP 67	IP 67	IP 65 or IP 67 (1)	IP 67	
Storage temperature	°C	-40...+80										
Operating temperature	°C	-20...+65			0...+60	0...+50	0...+60	-20...+65	0...+70	0...+60 or 0...+50 (1)	-20...+60	
Vibration resistance	Conforming to IEC 60068-2-6	Amplitude \pm 1 mm (f = 10...55 Hz); \pm 2 mm for XXV18B1●										
Mechanical shock resistance	Conforming to IEC 60068-2-27	30 gn, duration 11 ms, in all 3 axes 50 gn, duration 11 ms, in all 3 axes for XXV18B1●										
Resistance to electromagnetic interference		Conforming to IEC 60947-5-2										

(1) The first value is given for XX630A1● and XX630S1●, the second value for XX630A2●.
 (2) Double insulation for pre-cabled sensors. IP 69K for sensors with M12 connector.

Ultrasonic sensors

OsiSense XX, General purpose

Flat format, plastic

DC supply, solid-state output

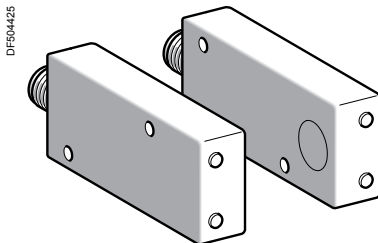
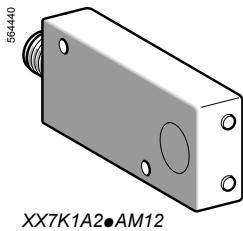
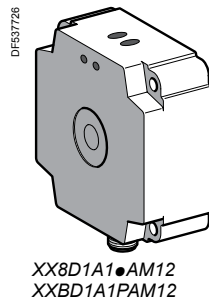
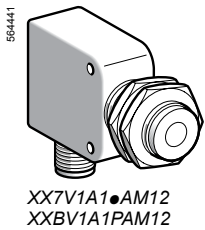
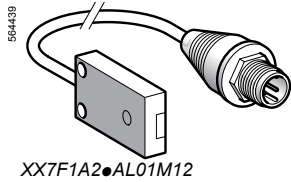

XX7K1A2●AM12 + XX7K1A2●AM12 (thru-beam system)

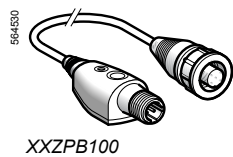

Diffuse system

Fixed sensing distance sensors

Sensors	Sensing distance (Sn)	Function/output	Connection	Reference	Weight
mm	m				kg
7.6 x 19 x 33	0.10	NO/NPN	152 mm flying lead + M12 connector	XX7F1A2NAL01M12	0.040
		NO/PNP	152 mm flying lead + M12 connector	XX7F1A2PAL01M12	0.040
16 x 30 x 74	0.25	NO/NPN	M12 connector	XX7K1A2NAM12	0.050
		NO/PNP	M12 connector	XX7K1A2PAM12	0.050

Adjustable sensing distance sensors

Sensors	Sensing distance (Sn)	Function/output	Connection	Reference	Weight
mm	m				kg
18 x 33 x 60 + Ø 18	0.50 (adjustable)	NO/NPN	M12 connector	XX7V1A1NAM12	0.060
		NO/PNP	M12 connector	XX7V1A1PAM12	0.060
80 x 80 x 34	1 (adjustable)	NO/NPN	M12 connector	XX8D1A1NAM12	0.300
		NO/PNP	M12 connector	XX8D1A1PAM12	0.300

Reflex system

Adjustable sensing distance sensors

Sensors	Sensing distance (Sn)	Function/output	Connection	Reference	Weight
mm	m				kg
18 x 33 x 60 + Ø 18	0.50 (adjustable)	NO/PNP	M12 connector	XXBV1A1PAM12	0.060
80 x 80 x 34	1 (adjustable)	NO/PNP	M12 connector	XXBD1A1PAM12	0.300

Thru-beam system

Sensors	Sensing distance (Sn)	Function/output	Connection	Reference	Weight
mm	m				kg
7.6 x 19 x 33					
Transmitter	0.20		152 mm flying lead + M12 connector	XXTF1A8M12L	0.030
Receiver	0.20	NO/PNP + NO/NPN	152 mm flying lead + M12 connector	XXRF1A8KAM12L	0.030
		NC/PNP + NC/NPN	152 mm flying lead + M12 connector	XXRF1A8KBM12L	0.030
16 x 30 x 74					
Transmitter	0.61		M12 connector	XXTK1A3M12	0.060
Receiver	0.61	NO/PNP + NO/NPN	M12 connector	XXRK1A3KAM12	0.060
		NC/PNP + NC/NPN	M12 connector	XXRK1A3KBM12	0.060
Transmitter	1		M12 connector	XXTK1A4M12	0.060
Receiver	1	NO/PNP + NO/NPN	M12 connector	XXRK1A4KAM12	0.060
		NC/PNP + NC/NPN	M12 connector	XXRK1A4KBM12	0.060

Accessories

Description	For use with sensor	Reference	Weight
			kg
Teach pushbutton	XX7V1A1●AM12, XX8D1A1●AM12, XXBV1A1●AM12 and XXBD1A1●AM12	XXZPB100	0.035
Selection of detection window			
Length of cable: 152 mm			
Input:			
M12 female connector			
Output:			
M12 male connector			

Other connection and fixing accessories

See page 24.

Ultrasonic sensors

OsiSense XX, General purpose

Flat format, plastic

DC supply, solid-state output

Sensor type		XX7F●	XXTF● XXRF●	XX7K●	XXTK● XXRK●	XX7V● XXBV1●	XX8D● XXBD●
General characteristics							
Conformity to standards		CE, IEC 60947-5-2					
Product certifications		UL, cCSAus	UL	cCSAus	UL	UL, cCSAus (1)	UL, cCSAus (1)
Nominal sensing distance (Sn)	m	0.1	0.2	0.25	0.6 (XX●K1A3) 1 (XX●K1A4)	0.5	1
Blind zone (in diffuse mode the object is not detected in this zone, in reflex mode the background is not detected in this zone)	mm	0...6.4	–	0...51	–	0 ... 51 (XX7V1●) 0 ... 165 (XXBV1●)	0 ... 100 (XX8D●) 0 ... 315 (XXBD●)
Detection window		Fixed	Fixed	Fixed	Fixed	Remotely adjustable or by using teach button	
Detection system	Diffuse	●	–	●	–	●	●
	Reflex	–	–	–	–	●	●
	Thru-beam	–	●	–	●	–	–
Transmission frequency	kHz	500	500	500	200	300	180
Differential travel	mm	< 0.7	–	< 0.35	–	< 2.5	< 2.5
Repeat accuracy	mm	± 0.7	± 0.79	± 0.7	± 0.79	± 1.27	± 1.6
Overall beam angle (see detection lobe)		14°	10°	14°	20°	12°	7°
Minimum size of object to be detected		Cylinder Ø 2.5 mm or flat bar 1 mm wide up to 50 mm	Cylinder Ø 12.2 mm at a distance of 200 mm	Cylinder Ø 1.6 mm up to 76 mm	XX●K1A3: Cylinder Ø 38 mm at a sensing distance of 600 mm XX●K1A4: Cylinder Ø 114 mm at a distance of 1 m	Cylinder Ø 2.5 mm or flat bar 1 mm wide for a sensing distance of 150 mm	Cylinder Ø 50 mm up to 1 m
Materials	Case	ULTEM®	ULTEM®	ULTEM®	ULTEM®	Valox®	Valox®
	Sensing face (2)	Epoxy	Epoxy	Silicone	Silicone	Epoxy	Epoxy
Connection	Connector	M12, 4-pin, on 152 mm flying lead	M12, 4-pin, on 152 mm flying lead	M12, 4-pin	M12, 4-pin	M12, 4-pin	M12, 4-pin
Supply characteristics							
Rated supply voltage	V	12...24 V $\overline{\text{---}}$ with protection against reverse polarity					
Voltage limits (including ripple)	V	10...28 V $\overline{\text{---}}$					
Current consumption, no-load	mA	25	50	60	XX●K1A3: 60 XX●K1A4: 100	40	70
Output characteristics							
LED indicators	Output state	Yellow LED					
	Power on	Green LED				–	Green LED
	Setting-up assistance	–	–	–	–	Multicolour LED	
Switching capacity (PNP and NPN)	mA	< 100, NO or NC function					
Voltage drop (PNP and NPN)	V	< 1	< 1.1	< 1	< 1	< 1	< 1
Maximum switching frequency	Hz	100	125	80	125	40	72
Delays	First-up	ms	20	20	350	200	100
	Response	ms	4	4	5	5	10
	Recovery	ms	4	4	5	5	10
Environment characteristics							
Degree of protection	Conforming to IEC 60529 and IEC 60947-5-2	IP 67					
Storage temperature	°C	- 40...+ 80					
Operating temperature	°C	- 20...+ 65	0...+ 50	- 20...+ 65	- 20...+ 65	0...+ 70	
Vibration resistance	Conforming to IEC 60068-2-6	Amplitude ± 1 mm (f = 10...55 Hz)					
Mechanical shock resistance	Conforming to IEC 60068-2-27	30 gn, duration 11 ms, in all 3 axes					
Resistance to electromagnetic interference		Conforming to IEC 60947-5-2					

(1) Only XX7V● and XX8D● sensors are cCSAus certified.
 (2) Silicone face for optimum chemical resistance.

Ultrasonic sensors

OsiSense XX, Application

Plastic case, cylindrical type and flat format

Sensors with analogue output signal 0... 10 V or 4-20 mA

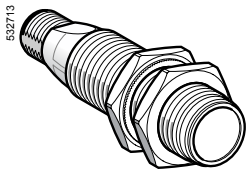

XX918A3●●M12

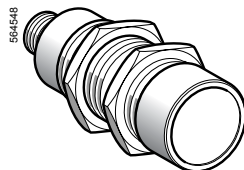

XX930A1A●M12

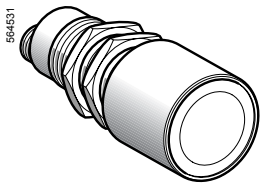

XX930A3A●M12

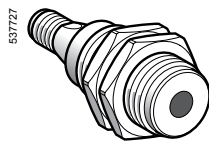

XX9V3A1●●M12

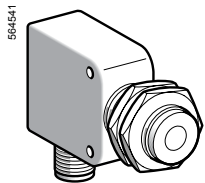

XX9V1A1●●M12

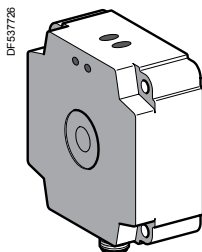

XX9D1A1●●M12



XXZPB100

Cylindrical sensors

Sensors	Sensing distance (Sn) m (adjustable)	Analogue output (Slope selection using teach button)	Reference	Weight kg
Standard analogue output				
Ø 18	0.5	4-20 mA	XX918A3C2M12	0.033
		0-10 V	XX918A3F1M12	0.033
Ø 30	1	4-20 mA	XX930A1A2M12	0.095
		0-10 V	XX930S1A2M12 (1)	0.095
		0-10 V	XX930A1A1M12	0.095
		0-10 V	XX930S1A1M12 (1)	0.095
		4-20 mA	XX9V3A1C2M12	0.090
		0-10 V	XX9V3A1F1M12	0.090
2	4-20 mA	4-20 mA	XX930A2A2M12	0.095
		0-10 V	XX930A2A1M12	0.095
8	4-20 mA	4-20 mA	XX930A3A2M12	0.115
		0-10 V	XX930A3A1M12	0.115

250 ms delayed analogue output (for unstable object)

Ø 30	1	4-20 mA	XX930A1A2230M12	0.095
		0-10 V	XX930A1A1230M12	0.095
2	4-20 mA	4-20 mA	XX930A2A2230M12	0.095
		0-10 V	XX930A2A1230M12	0.095

Flat format sensors

Sensors	Sensing distance (Sn) m (adjustable)	Analogue output (Slope selection using teach button)	Reference	Weight kg
18 x 33 x 65 + Ø 18	0.5	4-20 mA	XX9V1A1C2M12	0.090
		0-10 V	XX9V1A1F1M12	0.060
80 x 80 x 34	1	4-20 mA	XX9D1A1C2M12	0.300
		0-10 V	XX9D1A1F1M12	0.300

Accessories

Teach pushbutton

Teach pushbutton	For use with sensors	Reference	Weight kg
Selection of detection window	XX918A●	XXZPB100	0.035
Length of cable: 152 mm	XX9V3A●		
Input: M12 female connector	XX9D1A●		
Output: M12 male connector			

Other connection and fixing accessories

See page 24.

(1) Stainless steel 303 case.

Ultrasonic sensors

OsiSense XX, Application

Plastic case, cylindrical type and flat format

Sensors with analogue output signal 0... 10 V or 4-20 mA

Sensor type		XX918A3●	XX9V1A1●	XX930A1● XX930A2● XX930S1●	XX930A3●	XX9V3A1●	XX9D1A1●		
General characteristics									
Conformity to standards		CE, IEC 60947-5-2							
Product certifications		UL, cCSAus		UL, cCSAus					
Nominal sensing distance (Sn)		m	0.5	0.5	1 or 2 (1)	8	1	1	
Blind zone (no object must pass through this zone whilst the sensor is operating)		mm	0...51		0...51 or 0...120 (1)	0...203	0...100	0...100	
Detection window		mm	Remotely adjustable or by using external teach button		Adjustable using teach button on sensor		Remotely adjustable or by using external teach button		
Transmission frequency		kHz	300		200	75	180	180	
Repeat accuracy		mm	1.27		± 0.9	± 2.54	± 0.9	± 1.6	
Overall beam angle (see detection lobe)			6°		10°	16°	7°	7°	
Minimum size of object to be detected			Cylinder Ø 2.5 mm or flat bar 1 mm wide for a sensing distance of 150 mm		Cylinder Ø 1.6 mm up to a sensing distance of 635 mm	Cylinder Ø 50.68 mm up to a sensing distance of 4732 mm	Cylinder Ø 50 mm up to a sensing distance of 1 m	Cylinder Ø 50 mm up to a sensing distance of 1 m	
Deviation angle from 90° of the object to be detected			± 7°		± 8°	± 5°	± 5°	± 5°	
Materials		Case	Valox®		ULTEM®: XX930A1● and XX930A2● Stainless steel 303: XX930S1●	ULTEM®	Valox®	Valox®	
		Sensing face (2)	Epoxy		Silicone	Epoxy			
Connection		Connector	M12, 4-pin						
Supply characteristics									
Rated supply voltage (with protection against reverse polarity)		V	12...24 V $\overline{\text{DC}}$		15...24 V $\overline{\text{DC}}$	15...24 V $\overline{\text{DC}}$	15...24 V $\overline{\text{DC}}$	15...24 V $\overline{\text{DC}}$	
Voltage limits (including ripple)		V	10...28 V $\overline{\text{DC}}$						
Current consumption, no-load		mA	40	40	60 or 80 (1)	60	60	70	
Output characteristics									
Slope type			Direct or inverse by using teach button, see page 31.						
LED indicators		Output state	Yellow LED						
		Power on	Green LED						
		Setting-up assistance	Dual colour LED						
Delays		First-up	ms	100	100	720	1200	75	75
Recovery time			ms	150	150	250 (delayed) 50 (standard)	250	180	180
Resistive load impedance		4-20 mA	Ω			10...500	10...500	10...350	10...350
		0-10 V	Ω			1 k...∞	1 k...∞	2 k...∞	2 k fixed
Environment characteristics									
Degree of protection		Conforming to IEC 60529 and IEC 60947-5-2	IP 67		IP 67	IP 65	IP 67	IP 67	
Storage temperature		°C	- 40...+ 80						
Operating temperature		°C	- 20...+ 65		0...+ 50	- 20...+ 60	0...+ 70	0...+ 70	
Vibration resistance		Conforming to IEC 60068-2-6	Amplitude ± 1 mm (f = 10...55 Hz)						
Mechanical shock resistance		Conforming to IEC 60068-2-27	30 gn, duration 11 ms, in all 3 axes						
Resistance to electromagnetic interference			Conforming to IEC 60947-5-2						

(1) The first value is given for XX930A1● and XX930S1●, the second value for XX930A2●.
 (2) Silicone face for optimum chemical resistance.

Ultrasonic sensors

OsiSense XX, Application

Sensors for monitoring 2 levels

Cylindrical plastic case, M18 x 1 and M30 x 1.5

DC supply, solid-state output

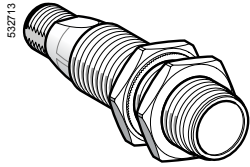

XX218A3●●M12

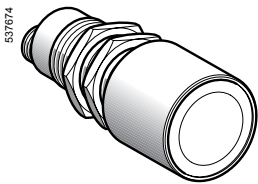

XX230A●1/●2●●●00M12

Sensors for monitoring levels

Sensors	Sensing distance (Sn)	Function/output	Reference	Weight
	m			kg
Ø 18, threaded M18 x 1				
2 emptying levels	0.5 (adjustable)	NO/NPN	XX218A3NHM12	0.035
		NO/PNP	XX218A3PHM12	0.035
2 filling levels	0.5 (adjustable)	NO/NPN	XX218A3NFM12	0.035
		NO/PNP	XX218A3PFM12	0.035
Ø 30, threaded M30 x 1.5				
2 levels 2 independent outputs	1 (adjustable)	NO/NPN + NO/NPN	XX230A12NA00M12	0.090
		NO/PNP + NO/PNP	XX230A12PA00M12	0.090
	2 (adjustable)	NO/NPN + NO/NPN	XX230A22NA00M12	0.090
		NO/PNP + NO/PNP	XX230A22PA00M12	0.090
2 emptying levels	1 (adjustable)	NO/PNP + NO/PNP	XX230A10PA00M12	0.090
		NO/PNP + NO/PNP	XX230A20PA00M12	0.090
2 filling levels	1 (adjustable)	NO/PNP + NO/PNP	XX230A11PA00M12	0.090
		NO/PNP + NO/PNP	XX230A21PA00M12	0.090

Accessories

Teach pushbutton

Teach pushbutton	For use with sensors	Reference	Weight kg
Selection of detection window Length of cable: 152 mm Input: M12 female connector Output: M12 male connector	XX218A3●	XXZPB100	0.035

Other connection and fixing accessories

See page 24.

Ultrasonic sensors

OsiSense XX, Application

Sensors for monitoring 2 levels

Cylindrical plastic case, M18 x 1 and M30 x 1.5

DC supply, solid-state output

Sensor type		XX218A3●●●●	XX230A1●●●●	XX230A2●●●●
General characteristics				
Conformity to standards		CE, IEC 60947-5-2		
Product certifications		UL, cCSAus	UL, cCSAus	UL, cCSAus
Nominal sensing distance (Sn)		m 0.50 (adjustable)	1 (adjustable)	2 (adjustable)
Blind zone (no object must pass through this zone whilst the sensor is operating)		mm 0...51	0...51	0...120
Detection window		Remotely adjustable or by using external teach button	Adjustable using teach button on sensor	
Transmission frequency		kHz 300	200	
Differential travel		mm < 2.5	< 2.5	< 2.5
Repeat accuracy		mm ± 1.27	± 0.9	
Overall beam angle (see detection lobe)		6°	10°	10°
Minimum size of object to be detected		Cylinder Ø 2.5 mm up to a sensing distance of 150 mm	Cylinder Ø 1.6 mm up to a sensing distance of 305 mm	
Deviation angle from 90° of the object to be detected		± 7°	± 10° on 305 x 305 mm	
Materials	Case	Valox®	ULTEM®	
	Sensing face (1)	Epoxy	Silicone	
Connection	Connector	M12, 4-pin		
Supply characteristics				
Rated supply voltage		V 12...24 V $\overline{\text{---}}$ with protection against reverse polarity		
Voltage limits (including ripple)		V 10...28 V $\overline{\text{---}}$		
Current consumption, no-load		mA 40	100	
Output characteristics				
LED indicators	Output state		Yellow LED	Multicolour LED
	Power on		Green LED	–
	Setting-up assistance		Dual colour LED	Multicolour LED
	Distance indication		–	Yellow LED
Switching capacity		mA < 100 (PNP and NPN) with overload and short-circuit protection		
Voltage drop		V < 1 (PNP and NPN)		
Delays	First-up	ms 100	1000	1000
	Response	ms 15	150	150
	Recovery	ms 1000	1000	1000
Environment characteristics				
Degree of protection		Conforming to IEC 60529 and IEC 60947-5-2	IP 67	IP 65
Storage temperature		°C - 40...+ 80	- 10...+ 80	
Operating temperature		°C - 20...+ 65	0...+ 50	
Vibration resistance		Conforming to IEC 60068-2-6	Amplitude ± 1 mm (f = 10...55 Hz)	
Mechanical shock resistance		Conforming to IEC 60068-2-27	30 gn, duration 11 ms, in all 3 axes	
Resistance to electromagnetic interference		Conforming to IEC 60947-5-2		

(1) Silicone face for optimum chemical resistance.

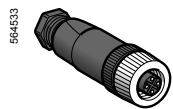

XZCC12FD•40B

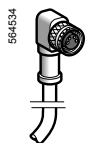

XZCP1041L

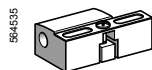

XSZB11



XUZA118

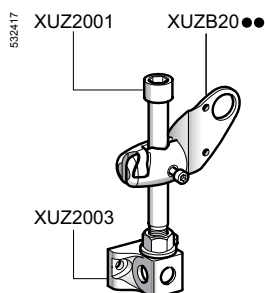

3D fixing kit example

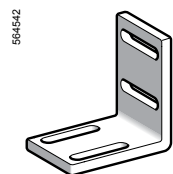

XXZ1933

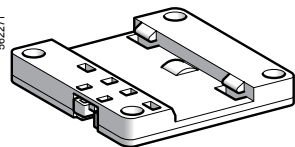

XSZBD10

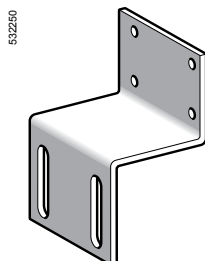

XXZ3074S

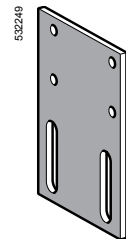

XXZ3074F

References of accessories

Cabling accessories

Connectors	For use with sensor	Type of connection		Reference	Weight kg
M8 3-pin	Ø 12 XX512A2	IDC (Insulation Displacement Connector)	Straight	XZCC8FDM30V	0.010
			Elbowed	XZCC8FCM30V	0.010
M8 4-pin	XX512A1 XX•12A8		Straight	XZCC8FDM40V	0.010
			Elbowed	XZCC8FCM40V	0.010
M12	Ø 18, Ø 30	Screw terminals, metal clamping ring	Straight	XZCC12FDM40B	0.020
			Elbowed	XZCC12FCM40B	0.020
		Screw terminals, plastic clamping ring	Straight	XZCC12FDP40B	0.020
			Elbowed	XZCC12FCP40B	0.020
Pre-wired connectors	For use with sensor	Type	Cable length m	Reference	Weight kg
M8 3-pin	Ø 12 XX512A2	Straight	2	XZCP0166L2 (1)	0.080
		Elbowed	2	XZCP0266L2 (1)	0.080
M12	Ø 18, Ø 30	Straight	2	XZCP1141L2 (1)	0.090
		Elbowed	2	XZCP1241L2 (1)	0.090

Fixing accessories

Description	For use with sensor	Reference	Weight kg	
Fixing clamps	Ø 12	XSZB112	0.006	
	Ø 18	XSZB118	0.010	
	Ø 30	XSZB130	0.020	
Fixing clamps (mounting on 35 mm rail)	XX•D	XSZBD10	0.065	
90° fixing bracket	Ø 12	XXZ12	0.025	
	Ø 18	XUZA118	0.038	
	Ø 30	XXZ30	0.115	
	XX7F	XXZ1933	0.025	
Flat mounting plate	XX7K	XXZ3074F	0.025	
Cranked mounting plate	XX7K	XXZ3074S	0.075	
3D fixing kit (2)	M12 rod	Ø 12, Ø 18 and Ø 30	XUZ2001	0.050
	Support for M12 rod	Ø 12, Ø 18 and Ø 30	XUZ2003	0.160
	Ball-joint mounted fixing bracket	Ø 12	XUZB2012	0.175
		Ø 18	XUZB2003	0.175
		Ø 30	XUZB2030	0.160

(1) For a 5 m long cable replace L2 by L5, for a 10 m long cable replace L2 by L10.

(2) To obtain a 3D fixing kit, order:

rod support XUZ2003, M12 rod XUZ2001 and ball-joint mounted fixing bracket XUZB20••

Dimensions

Fixing accessories

XUZA118

90° fixing bracket (Ø 18)

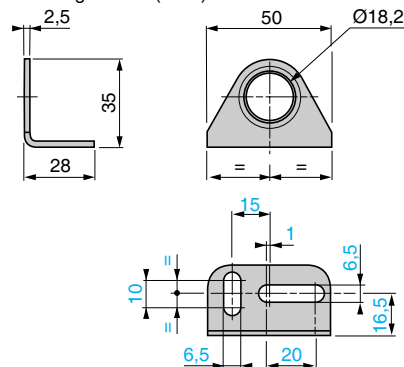

XXZ12, XXZ30

90° fixing bracket (Ø 12 and Ø 30)

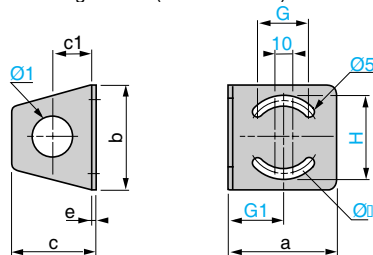

XXZ	a	b	c	c1	e	H	G	G1	Ø	Ø1
12	35	40	33	18	2	31	18	18	25	13
30	67	65	52	25	3	51	35	33	50	31

Dimensions (continued)

Fixing accessories (continued)

XSZB112, XSZB118

Fixing clamps (Ø 12, Ø 18 and Ø 30)

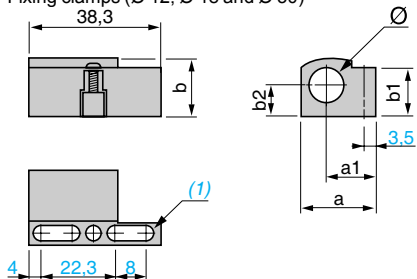

XSZ	a	a1	b	b1	b2	Ø
B112	21.9	14.5	16	15.5	8.5	12
B118	26	15.7	22.3	20.1	11.5	18
B130	39	21.7	35.5	31	18.5	30

(1) 2 elongated holes Ø 4 x 8.

XXZ3074F

Flat mounting plate (XX•K•)

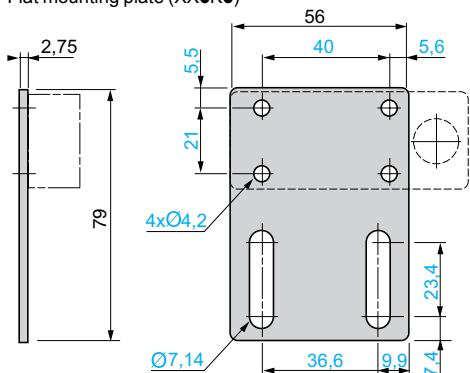

XXZ1933

90° fixing bracket (XX•F•)

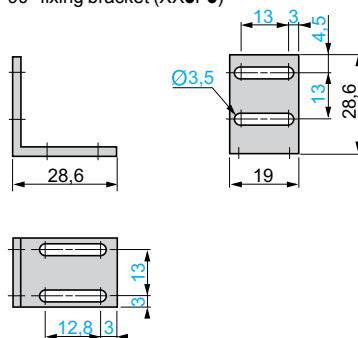

XXZ3074S

Cranked mounting plate (XX•K•)

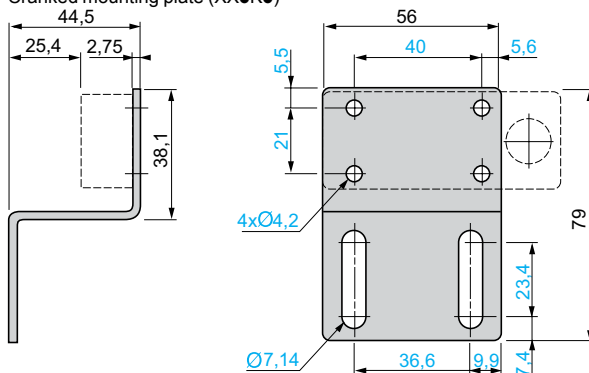

XUZ2001

M12 rod

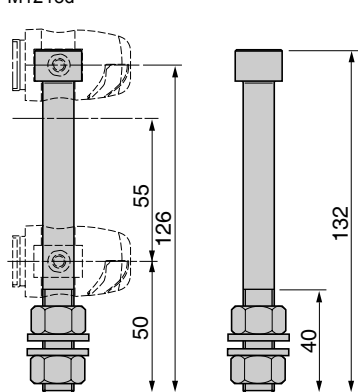

XUZ2003

Support for M12 rod

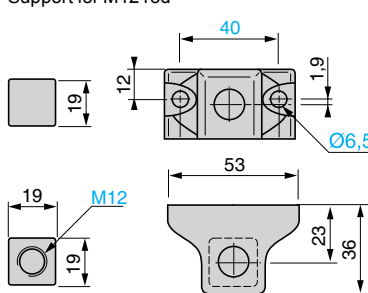

XSZBD10

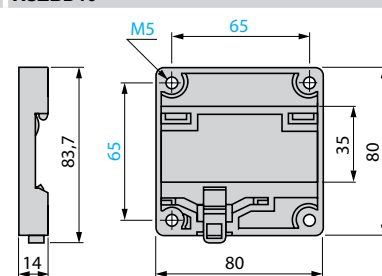

XUZB2012

Ball-joint mounted fixing bracket (Ø 12)

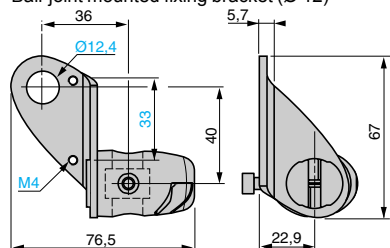

XUZB2003

Ball-joint mounted fixing bracket (Ø 18)

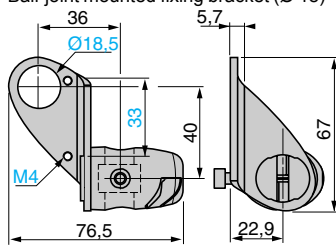

XUZB2030

Ball-joint mounted fixing bracket (Ø 30)

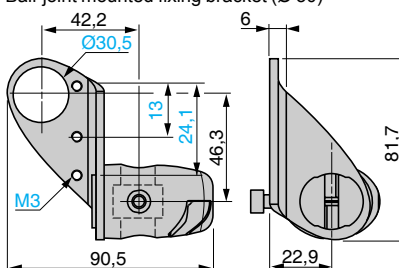

Dimensions

XX●12A●●●M8

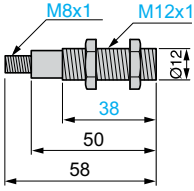

XX518A1KAM12
XXT18A●M12
XXR18A●●●●●

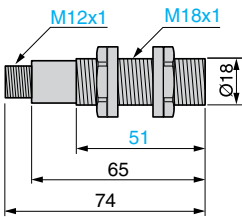

XX518A3●●L2

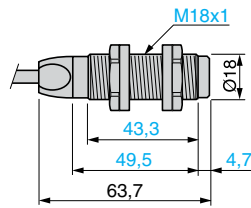

XX518A3●AM12
XXB18A3●AM12
XX918A3●AM12
XX218A3●●M12

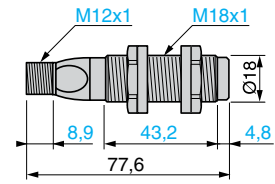

XXV18B1●●●M12

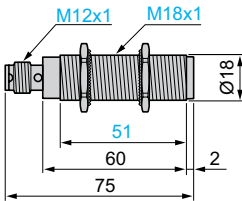

XXV18B1●●●L●

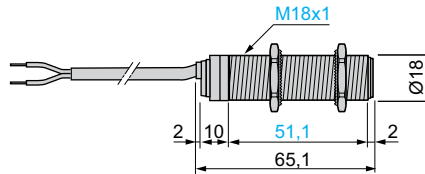

XX630A1●●M12
XX630S1●●M12
XX630A2●●M12
XX930A1A●M12
XX230A1●●A00M12
XX230A2●●A00M12

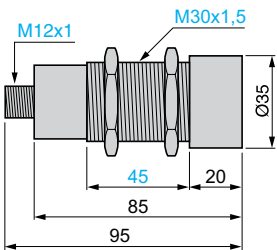

XX6V3A1●AM12
XXBV3A1●AM12
XX9V3A1●●M12

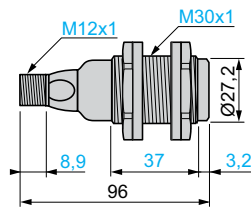

XX630A3●●M12
XX930A3A●M12

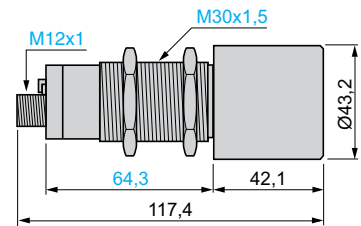

Dimensions

XX7F1A2●AL01M12
XXTF1A8●/XXR F1A8●

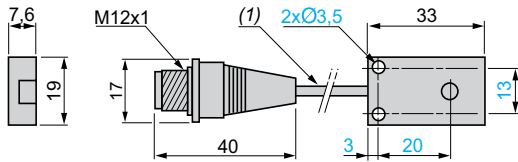

XX7K1A2●AM12
XXTK1A3●/A4●, XXRK1A3●/A4●

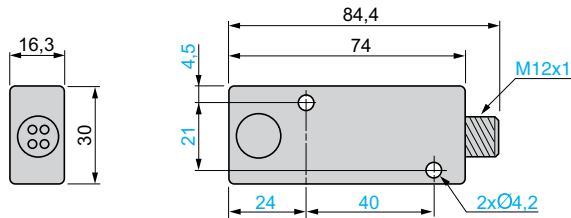

(1) Cable, length: 152 mm.

XX7V1A1●AM12
XXBV1A1●AM12

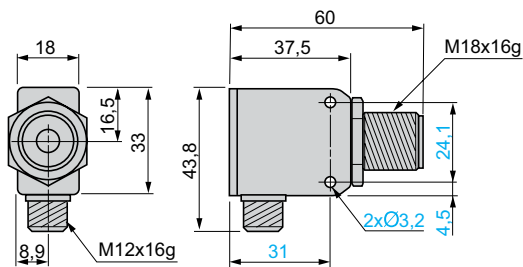

XX9V1A1●●M12

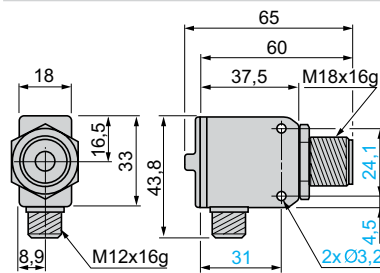

XX8D1A1●AM12
XXBD1A1●AM12
XX9D1A1●●AM12

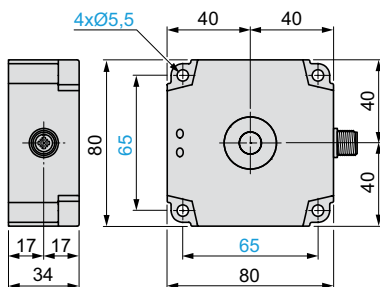

XXZPB100

Teach pushbutton

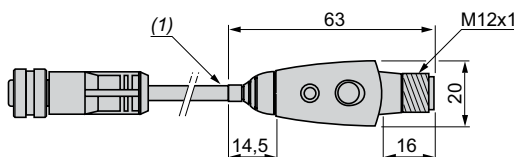

(1) Cable, length: 152 mm.

Schemes

Digital output, Ø 12 sensor, M8 connector

XX512A1KAM8

4-wire type

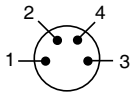

NO outputs, PNP and NPN

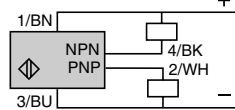

1 (+) 2 PNP output (-) BU (Blue) (+) BN (Brown)
3 (-) 4 NPN output WH (White) BK (Black)

XX512A2●

3-wire type



NO outputs, NPN

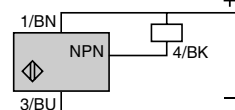

(-) BU (Blue) (+) BN (Brown) BK (Black)

NO outputs, PNP

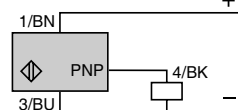

Digital output, Ø 18 sensor, M12 connector, Ø 30 (XX6V3●, XXBV3●)

XX518A1KAM12

4-wire type

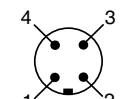

NO outputs, PNP and NPN

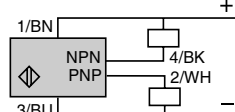

1 (+) 2 PNP output (-) BU (Blue) (+) BN (Brown)
3 (-) 4 NPN output WH (White) BK (Black)

XX518A3●, XXB18A3●, XX6V3●, XXBV3●, XX218A3●, XX7V1●, XXBV1●, XX8D1●, XXBD1●

3-wire type



NO outputs, NPN

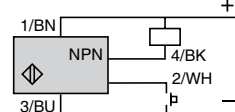

(-) BU (Blue) (+) BN (Brown) BK (Black)

NO outputs, PNP

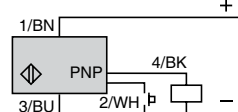

XXV18B1●●●M12

3-wire type

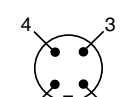

NO outputs, NPN

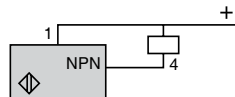

NO outputs, PNP

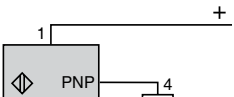

NC outputs, NPN

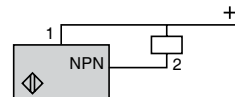

NC outputs, PNP

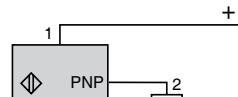

1 (+)
3 (-)

Digital output, Ø 18 sensor, pre-cabled

XXV18B1●●●L●

3-wire type

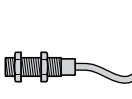

PNP/NO, NC NPN/NO, NC

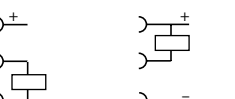

(-) BU (Blue) (+) BN (Brown) BK (Black)

XX518A3●●●L2

PNP output

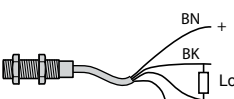

NPN output

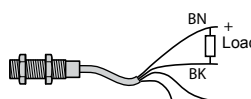

Digital output, Ø 30 sensor, M12 connector (XX630A●)

XX630A1KAM12

4-wire type

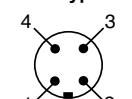

NO outputs, PNP and NPN

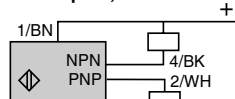

1 (+) 2 PNP output (-) BU (Blue) (+) BN (Brown)
3 (-) 4 NPN output WH (White) BK (Black)

XX630A●●●M12

NO + NC outputs, NPN

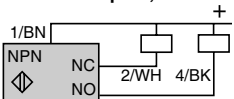

(-) BU (Blue) (+) BN (Brown) WH (White) BK (Black)

NO + NC outputs, PNP

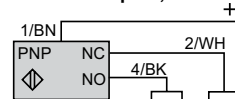

Thru-beam sensors: XXT12●/XXR12●, XXT18●/XXR18●, XXTF1●/XXRF1●, XXTK1●/XXRK1●

Transmitter

XXT12A8M8, XXT18A3M12, XXTF1A8M12L, XXTK1A●M12

M8

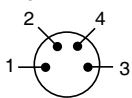

1 (+)
3 (-)

M12

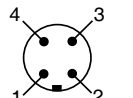

1 (+)
3 (-)

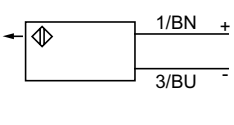

Receiver

XXR12A8K●M8, XXRF1A8●K●M12L, XXRK1A●K●M12

M8

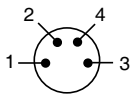

1 (+)
2 (PNP)
3 (-)
4 (NPN)

M12

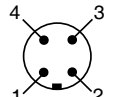

1 (+)
2 (PNP)
3 (-)
4 (NPN)

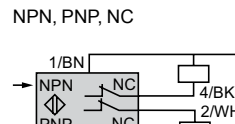
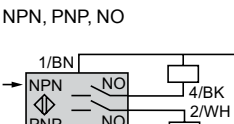

Note: See "NO output/NC output according to the detection mode" table on page 29.

Schemes (continued)

M12 connector, digital output (XXF●, XXK●)

3-wire type

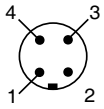

1 (+)
3 (-)
4 NPN or PNP output

XX7F1A2NAL01M12 (1),
XX7K1A2NAM12

NO outputs, NPN

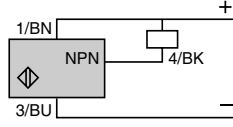

XX7F1A2PAL01M12 (1), XX7K1A2PAM12,

NO outputs, PNP

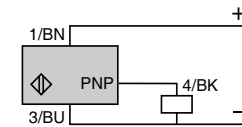

(-) BU (Blue)
(+) BN (Brown)
BK (Black)

(1) Remote connector on flying lead approximately 15 cm long.

M12 connector, analogue output

XX930A●/XX930S●

XX918A●/XX9V1A●/XX9V3A●/XX9D1●

4-wire type

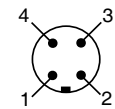

1 (+)
2 Return signal or teach
3 (-)
4 Output signal

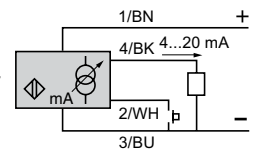
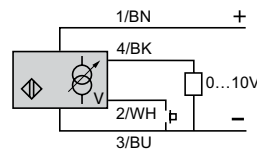
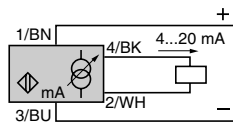
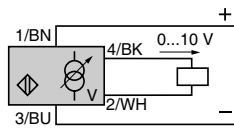

For impedance of resistive load refer to values on page 21.

BN (Brown)
WH (White)
BU (Blue)
BK (Black)

∅ 30 sensor, 2 digital outputs for monitoring 2 levels

XX230A●0●/XX230A●1●

XX230A●2●

NO + NO outputs, PNP

NO + NO outputs, NPN

NO + NO outputs, PNP

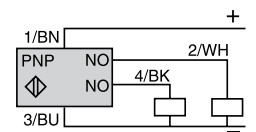
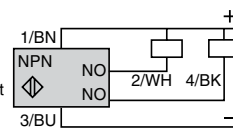
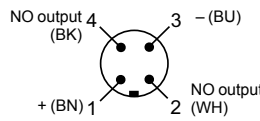
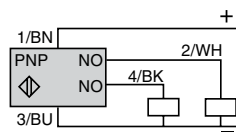
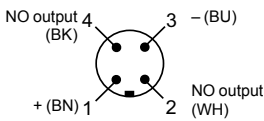

BN (Brown) WH (White) BU (Blue) BK (Black)

Wiring for teaching of detection window

Using external contact
XX●18A3●/XX●V3●/XX●D1●

With XXZPB100

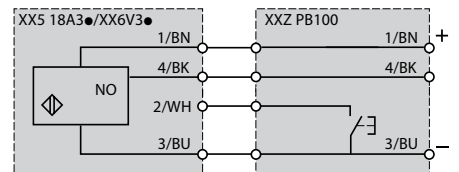
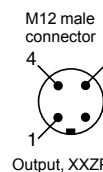
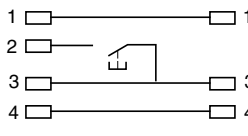
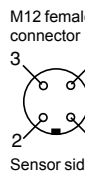
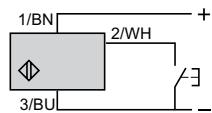

Note: Terminal 2 must be disconnected during product use.

1 (+) BN (Brown)
2 WH (White)
3 (-) BU (Blue)
4 BK (Black)

NO output/NC output according to the detection mode

	NO output	NC output
No object present	LED	
Diffuse mode	Output state	
Thru-beam mode		
Reflex mode		
Object present	LED	
Diffuse mode	Output state	
Thru-beam mode		
Reflex mode		

(1) Fixed background of machine
(2) Object

Setting-up precautions

Minimum mounting distances

Diffuse sensors, cylindrical type

Side by side

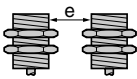

Face to face

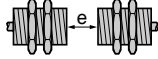

e: respect the distances indicated on the detection curves

$$e \geq 4 \times S_n$$

Diffuse sensors, flat format

Side by side

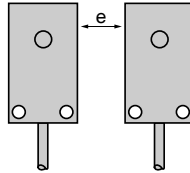

e: respect the distances indicated on the detection curves

XXV18●

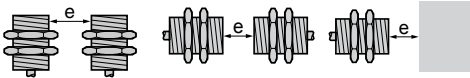

e > 25 mm

e > 700 mm

e > 60 mm

Thru-beam sensors

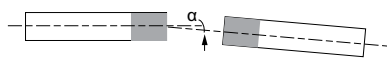

Sensors	α
XX●12●●/XX●F1●●	$\pm 5^\circ$
XX●18A3●●/XX●K1A3●●●	$\pm 8^\circ$
XX●18A4●●/XX●K1A4	$\pm 10^\circ$
XX●18A2●●/XX●K1A2	

XX512A1KAM8

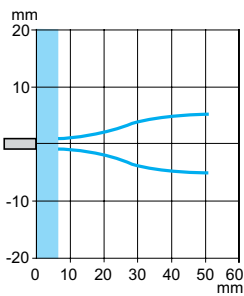

XX512A2●NAM8

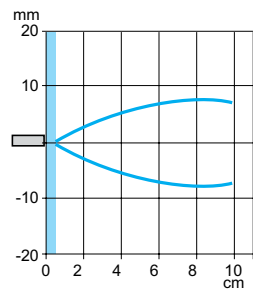

XX518A1KAM12

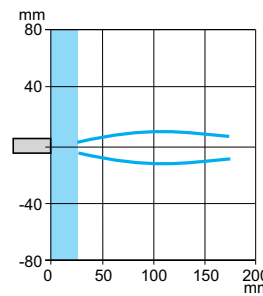

XX218A3●●M12, XX518A3●●L2, XXB18A3●AM12, XX518A3●AM12, XX7V1A1●AM12, XXBV1A1●AM12, XX918A3●M12, XX9V3A1●M12

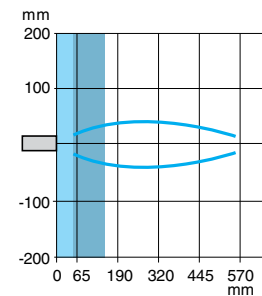

XXV18B1●

Square object

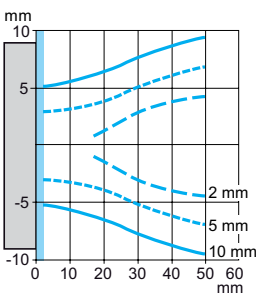

Cylindrical object

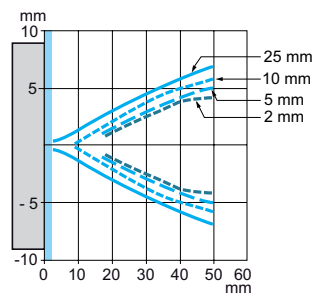

XX630A2●CM12

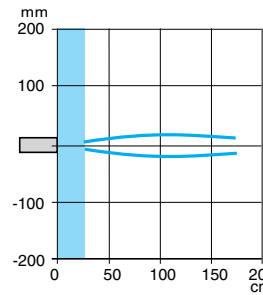

XX630A3●CM12 XX930A3●M12

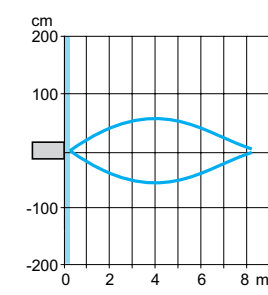

XX230A1●, XX630A1●CM12, XX6V3A1●AM12, XXBV3A1●AM12, XX930A1●M12, XX9V3A1●M12, XX8D1A1●AM12, XXBD1A1●AM12

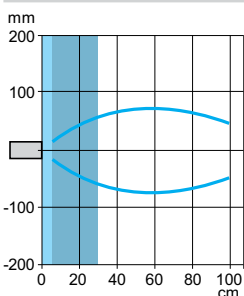

XX7F1A2●AL01M12

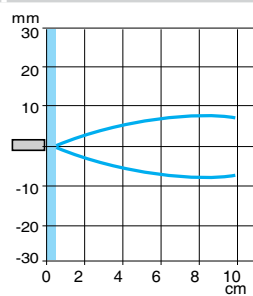

XX7K1A2●AM12

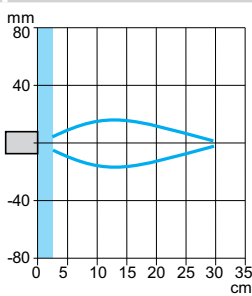

XX230A2●

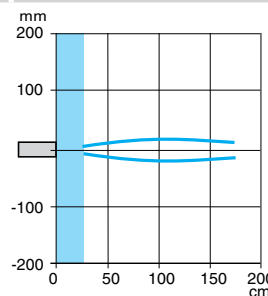

Blind zone for diffuse sensors.

Blind zone for reflex sensors.

Output signal curve

Sensors with analogue output signal 0... 10 V or 4-20 mA

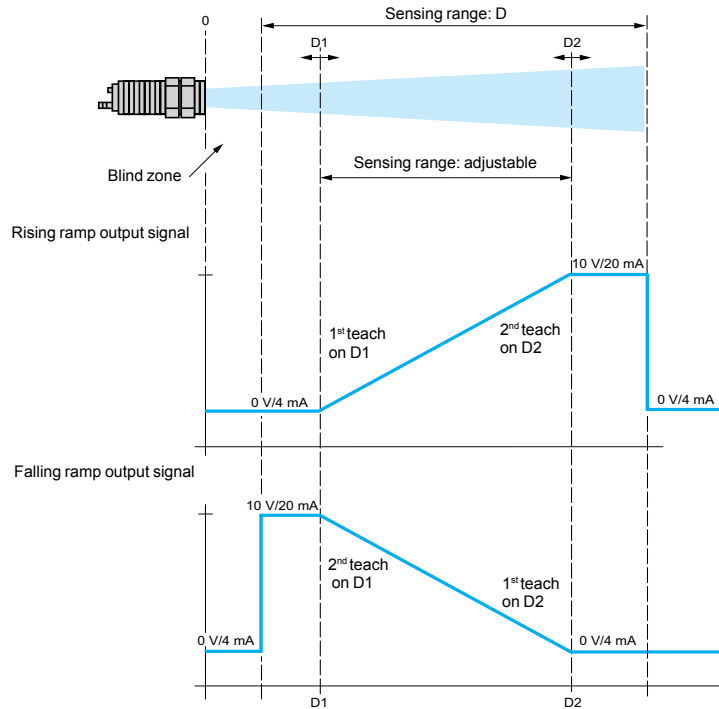

The direction of the slope of the signal is obtained by teaching the first limit:
 - D1 for rising ramp
 - D2 for falling ramp

Maximum deviation < 0.5%

Operating curves

XX218A3●H●/XX230A●0●

Emptying (stored in high threshold memory)

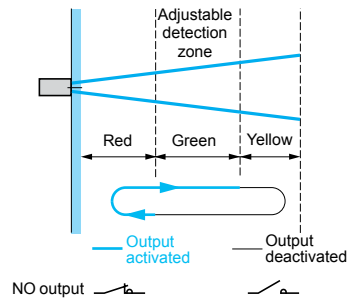

XX218A3●F●/XX230A●1●

Filling (stored in low threshold memory)

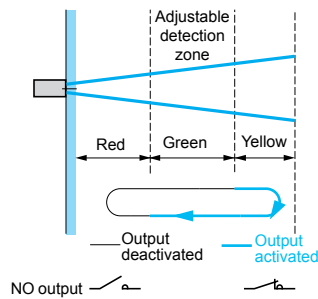

XX230A●2●

2 levels, 2 independent outputs

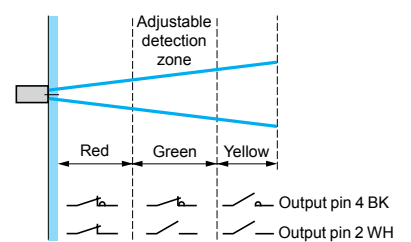

Note:

One output is available on the Ø 18 (XX218●)
 Two outputs are available on the Ø 30 (XX230●)

X			
XSZB112	24	XX930A1A2230M12	20
XSZB118	24	XX930A1A2M12	20
XSZB130	24	XX930A2A1230M12	20
XSZBD10	24	XX930A2A1M12	20
XUZ2001	24	XX930A2A2230M12	20
XUZ2003	24	XX930A2A2M12	20
XUZA118	24	XX930A3A1M12	20
XUZB2003	24	XX930A3A2M12	20
XUZB2012	24	XX930S1A1M12	20
XUZB2030	24	XX930S1A2M12	20
XX218A3NFM12	22	XXB18A3PAM12	15
XX218A3NHM12	22	XXBD1A1PAM12	18
XX218A3PFM12	22	XXBV1A1PAM12	18
XX218A3PHM12	22	XXBV3A1PAM12	15
XX230A10PA00M12	22	XXR12A8KAM8	15
XX230A11PA00M12	22	XXR12A8KBM8	15
XX230A12NA00M12	22	XXR18A3KAM12	15
XX230A12PA00M12	22	XXR18A3KBM12	15
XX230A20PA00M12	22	XXR18A4KAM12	15
XX230A21PA00M12	22	XXR18A4KBM12	15
XX230A22NA00M12	22	XXRF1A8KAM12L	18
XX230A22PA00M12	22	XXRF1A8KBM12L	18
XX512A1KAM8	14	XXRK1A3KAM12	18
XX512A2NAM8	14	XXRK1A3KBM12	18
XX512A2PAM8	14	XXRK1A4KAM12	18
XX518A1KAM12	14	XXRK1A4KBM12	18
XX518A3NAL2	14	XXT12A8M8	15
XX518A3NAM12	14	XXT18A3M12	15
XX518A3PAL2	14	XXT18A4M12	15
XX518A3PAM12	14	XXTF1A8M12L	18
XX6V3A1NAM12	14	XXTK1A3M12	18
XX6V3A1PAM12	14	XXTK1A4M12	18
XX630A1KAM12	14	XXV18B1NAL10	14
XX630A1NCM12	14	XXV18B1NAL2	14
XX630A1PCM12	14	XXV18B1NAL5	14
XX630A2NCM12	14	XXV18B1NAM12	14
XX630A2PCM12	14	XXV18B1NBL10	14
XX630A3NCM12	14	XXV18B1NBL2	14
XX630A3PCM12	14	XXV18B1NBL5	14
XX630S1NCM12	14	XXV18B1NBM12	14
XX630S1PCM12	14	XXV18B1PAL10	14
XX7F1A2NAL01M12	18	XXV18B1PAL2	14
XX7F1A2PAL01M12	18	XXV18B1PAL5	14
XX7K1A2NAM12	18	XXV18B1PAM12	14
XX7K1A2PAM12	18	XXV18B1PBL10	14
XX7V1A1NAM12	18	XXV18B1PBL2	14
XX7V1A1PAM12	18	XXV18B1PBL5	14
XX8D1A1NAM12	18	XXV18B1PBM12	14
XX8D1A1PAM12	18	XXZ12	24
XX9D1A1C2M12	20	XXZ1933	24
XX9D1A1F1M12	20	XXZ30	24
XX9V1A1C2M12	20	XXZ3074F	24
XX9V1A1F1M12	20	XXZ3074S	24
XX9V3A1C2M12	20	XXZPB100	15
XX9V3A1F1M12	20		18
XX918A3C2M12	20		20
XX918A3F1M12	20		22
XX930A1A1230M12	20	XZCC12FCM40B	24
XX930A1A1M12	20	XZCC12FCP40B	24
		XZCC12FDM40B	24
		XZCC12FDP40B	24
		XZCC8FCM30V	24
		XZCC8FCM40V	24
		XZCC8FDM30V	24
		XZCC8FDM40V	24
		XZCP0166L2	24
		XZCP0266L2	24
		XZCP1141L2	24
		XZCP1241L2	24

Schneider Electric Industries SAS

Head Office
35, rue Joseph Monier
F-92500 Rueil-Malmaison
France

www.tesensors.com

The information provided in this documentation contains general descriptions and/or technical characteristics of the performance of the products contained herein. This documentation is not intended as a substitute for and is not to be used for determining suitability or reliability of these products for specific user applications. It is the duty of any such user or integrator to perform the appropriate and complete risk analysis, evaluation and testing of the products with respect to the relevant specific application or use thereof. Neither Schneider Electric nor any of its affiliates or subsidiaries shall be responsible or liable for misuse of the information contained herein.

Design: Schneider Electric
Photos: Schneider Electric